

Contract Book

Outdoor living in the project business





Everyman Cinema, Horsham (UK) – PALAZZO® Noblesse

Contents

Glatz	4
Contract Book	8
Places of use	12
Giant parasols	16
Centre pole parasols	34
Side mast parasols	52
Wooden parasols	62
Fabric collection	72
Fixations	74
Additional options – Standard accessories	88
Special product solutions – Made to measure	94
Checklist – Have you thought of everything?	100
Marketing – Legal notice	102

The original
Swiss parasol
since 1895

Glatz

Superior sun protection with splendid radiance

The architectural demands on the outdoor areas of hotels and restaurants, public spaces, universities, leisure facilities and elegant estates require a wealth of imagination and specialist knowledge.

It is therefore worthwhile to discuss the approach to shading with our specialists at an early stage. The lasting message evoked by the right parasols is increasingly becoming a hallmark for outdoor locations.

A holistic shade solution requires quality from the first step to the last. Whether for planning, design, product development or project-specific individual solutions made to measure: we always strive for top performance when it comes to reliable sun protection for outdoor areas.

The Glatz project department has been committed to straightforward dialogue with national and international customers for years. Alongside sales partners, it assists architects, planners, interior designers, engineers, restaurateurs and hoteliers in their search for optimal shade solutions.

As the manufacturer, we support you with our many years of experience and consulting expertise, with innovative ideas, full technical support and our typical Swiss perfectionism. Welcome!



Markus Glatz & the Glatz team

Glatz Contract

Visionary ideas require visionary enablers

If you, as an architect, interior designer, urban planner, contract fitter, restaurateur or hotel owner, want to replan and design an outdoor area on a patio or rooftop, at an entrance, or on a piazza in the city centre or by the water, you can use this opportunity to shape the long-term identity of your property and create a "place to be".

Finding the best possible shading solution in sophisticated and identity-establishing locations is a complex matter. Our shading professionals, with their decades of experience, are at your side so you can fully concentrate on your goals when it comes to your vision for the outdoor space. Your parasol ensemble is thereby always in top form, even in extreme weather and in particularly challenging locations.

Tailored shade comfort, practical handling, full shape harmony, lighting concepts for the right atmosphere even after sunset, super-secure fastening technology, stylish integration into the big picture and much more. The sooner you talk to us, the more efficient and easier the path to your goal will be.

Glatz Contract is your centre of excellence for individual property consulting and project-specific parasol solutions. We'll never leave you stranded in the sun.

Do you want to get directly in touch with the manufacturer?

Please do not hesitate to call us on +41 52 723 66 44

**Glatz supports you in creating places
where people get together**



Place de Paris, Quebec (CA) – Cities are turning their public spaces into attractive focal points

Contract Book

Your tool for project planning

The earlier and more precisely you plan the outdoor shading space, the better the solution will be. The Glatz Contract Book is your practical tool for holistic shade planning.

Well-structured manual

For the best solution with Glatz parasols

Range of products

Specifically for the professional place of use

Fixations

The right solution for every situation

Standard accessories

Lighting, heaters, rain gutters and much more

Special product solutions

Made to measure

Project consulting step by step

Step 1 – Identifying the place of use (see page 12)

- Large area outdoors
- Small area outdoors
- Terraces & rooftops
- Public spaces & parks
- Corrosive environments

Step 2 – Detailed situation analysis

- Spatial conditions – Measuring the area, gradient & obstacles → Parasol size & mass
- What is to be shaded – No need to move the furniture → Closing height
- Surface characteristics & ground structure details → Fixation
- Weather conditions & weather influences – Wind, rain & snow → Choice of material
- Extreme locations – Wind & corrosion resistance → Stability & Corrosion protection
- Observe the consulting guide for locations exposed to wind → see page 14

Step 3 – Specific customer requirements

Ambiance

- Outdoor Living – Harmony between the environment, architecture & furnishings
- Frame colours, choice of fabrics & material

Usable area

- Full coverage canopy solution
- Open & flexible sharing solution

Handling

- Quick & easy – Crank, tensioning lever, motor or pulley system

Customisation

- Electronic systems – Lighting, heating, motorisation, ...
- Textiles – Rain gutters, side walls, ...
- Made to measure – Sizes, shapes, frame colours, ...

Parasols

Specifically for the project business

Giant parasols

PZR PALAZZO® Royal
A Swiss masterpiece

PZN PALAZZO® Noblesse
The giant parasol for the ambitious

PZS PALAZZO® Style
The stylish parasol

CAS CASTELLO® Pro
The versatile allrounder

Centre pole parasols

FL FORTELLO®
The large-size windproof parasol

FR FORTERO®
The medium-size windproof parasol

FI FORTINO® Riviera
The compact windproof parasol

AS ALU-SMART
The small and adaptable parasol

Side mast parasols

AMB AMBIENTE Nova
The queen of the side-mast parasols

FA FORTANO®
The windproof side-mast parasol

Wooden parasols

TW TEAKWOOD
The elegant masterpiece in precious timber

AL ALEXO®
The classic parasol since 1931



25Hours Hotel Langstrasse, Zurich (CH) – The optimal mix of models for a unique concept

Places of use

Architecture, environment, furniture in harmony

When people meet outdoors, they want a beautiful shady spot. It's not just the aesthetics of parasols that are part of modern architecture and landscape design – people often associate an emotional relationship with their favourite spot of shade under the sun.

Glatz Contract makes sure that the inner value matches the property. We focus on the factors of wind stability, handling, customisation and design, fabric quality, fastening technology and much more.

As a partner, we are at your side with our parasol expertise, from situation analysis to implementation. Whether idyllic hostels in the country, cool boutique hotels in the city, stylish rooftops, trendy restaurants, summery beach cafés, urban pedestrian zones, public meeting places, holiday resorts or playgrounds and parks – these spaces all have one thing in common: they are the sought-after attractions where people meet and enjoy themselves.

The right parasol for your place of use

Glatz has analysed the various locations and categorised them into similar or consistent places of use. Depending on the location, Glatz recommends a model selection tailored and geared toward the situation.



Large area outdoors

PZR PZN CAS AMB

- Hotels & restaurants
- Cities, towns & communities
- Hospitals & care homes
- Universities & businesses (canteens)



Small area outdoors

PZS CAS FL FR FI AS AMB FA TW AL

- Hotels, restaurants, cafés & bars
- Takeaways
- Pedestrianised areas & pavements
- Shopping centres & malls



Terraces & rooftops

PZR PZN PZS CAS FL FI

- Hotels, restaurants & bars
- Exclusive architecture
- Urban living & high-rise buildings
- Shopping centres & malls



Public spaces & parks

PZN PZS CAS FL FR FI

- Cities, towns & communities
- Parks
- Playgrounds
- Schools and nurseries



Corrosive environments

PZR PZN PZS CAS FI AS

- Hotels, restaurants, cafés & bars
- Seaside promenades
- Coastal regions
- Swimming pools & pool facilities

Consulting guide

Locations exposed to wind

Sensitive locations

- Elevated sites (roof terraces, hills, mountains, ...)
- Sparsely developed areas and foehn valleys
- Lake shores, promenades and coastal regions

The right parasol selection

Wind-stable centre pole parasols up to a certain size are the best choice for wind-exposed locations. **Important:** Side mast parasols are not suitable in such locations!

- Centre pole parasols with the best possible wind stability are a must:
Palazzo Line, Castello Pro or F-Line
- It is better to plan several smaller parasols instead of one large one,
e.g. four 350 × 350 cm parasols instead of one 700 × 700 cm parasol
- If available, use parasols with a higher number of pieces,
e.g. Palazzo Noblesse, 500 × 500 cm 12 parts instead of 8 parts
- The following dimensions are not recommended:
Palazzo Royal larger than 600 cm
Palazzo Noblesse larger than 500 cm
Palazzo Style larger than 450 cm
Castello Pro larger than 450 cm
- Closing motorised parasols is not possible at wind speeds above 35 km/h

Fixations

- Basic recommendation – choose fixed anchorage (see fixations, p. 74)
- Max. permissible wind speeds require fixed anchoring into the ground
- Anchoring must be professionally installed or fitted (specialist on site)
- Wall consoles are not permitted

Winter storage

- Parasols in extremely exposed locations should be taken down in winter
- Parasols must be professionally tied and provided with a protective cover



Monte Generoso, Ticino (CH/IT) – high wind speeds don't impress us. We'd rather do the impressive.

Giant parasols

PALAZZO® Line

The Palazzo giant parasol range with the models Style, Noblesse and Royal is more in demand than ever in the contract sector. All three models are ideal for large outdoor areas, ensure a modern aesthetic with their flat parasol roof, withstand wind speeds of up to 115 km/h and provide reliable protection from the sun and rain.

The patented opening principle of the Palazzo line is absolutely unique. With only 9 to 19 turns of the crank depending on size, the three models can be opened in no time at all. Motorised parasols are also available for those who prefer to open their parasols as if by magic.

The LED lighting system is directly and indirectly integrated into the ribs and can be controlled via an intuitive remote control.

There are no limits for shape and size. Depending on the location, special sizes are available tailored in five-centimetre increments. The Palazzo range stands out through its distinctive design and intrinsic values. This gives every discerning outdoor area that *je ne sais quoi*.

CASTELLO® Pro

This parasol is the ideal host in an outdoor space. Like the Palazzo line, it features an opposing opening system. In contrast to the Palazzo crank, the Castello Pro can be opened and closed using a tensioning lever. The tensioning lever can be locked to protect against unauthorised operation.

Its puristic shapes and the modern, flat roof give the Castello Pro a timelessly modern and fascinating design. Visually, it harmonises perfectly with the models of the F line and ensures a uniform appearance when combined



PZR PALAZZO® Royal
A Swiss masterpiece

18

- 400 to 800 cm + special sizes made to measure
- Max. 110 km/h wind stability
- Counter-rotating opening principle (crank or motor)
- Opened with just 19 turns of the crank (patented)
- Professional additional options (LED, heating, ...)
- Special product solutions (frame, fabrics, ...)



PZN PALAZZO® Noblesse
The giant parasol for the ambitious

22

- 300 to 700 cm + special sizes made to measure
- Max. 95 km/h wind stability
- Counter-rotating opening principle (crank or motor)
- Opened with just 12 turns of the crank (patented)
- Professional additional options (LED, heating, ...)
- Special product solutions (frame, fabrics, ...)



PZS PALAZZO® Style
The stylish parasol

26

- 200 to 600 cm + special sizes made to measure
- Max. 115 km/h wind stability
- Counter-rotating opening principle (crank or motor)
- Opened with just 9 turns of the crank (patented)
- Professional additional options (LED, heating, ...)
- Special product solutions (frame, fabrics, ...)



CAS CASTELLO® Pro
The versatile allrounder

30

- 300 to 600 cm + special sizes made to measure
- Max. 100 km/h wind stability
- Counter-rotating opening principle
- Quick and easy operation using tensioning lever
- Professional additional options (LED, heating, ...)
- Special product solutions (frame, fabrics, ...)



- 1 Schlosshotel ***** Superior – Ischgl, AT
- 2 Restaurant de Koperen Vis – Monnickendam, NL
- 3 Art Deco Hotel Montana – Lucerne, CH
- 4 Falkensteiner Hotel & Spa – Jesolo, IT
- 5 Der Öschberghof – Donaueschingen, DE



PALAZZO® Royal
A Swiss masterpiece



Unique selling proposition

- Palazzo line design language: uniform design of the models Royal, Noblesse and Style
- Continuous mast profile down to the floor covering (internal tip-over hinge)
- Counter-rotating opening principle (with crank or motor):
Opened with just 19 turns of the crank (patented)
High closing height (no need to move the furniture)
- 110 km/h wind stability at size 500 × 500 cm
- Top quality material selection
- LED lighting system integrated into the struts
- Professional additional options (Heating, rain gutters, ...)
- Special product solutions (Sizes, frame, fabrics, ...)

Places of use

- Large area outdoors
- Terraces & rooftops
- Corrosive environments





Basic model

Frame

- 10, 12 or 14 parts made from anodised aluminium
- Anti-rotation mast including reinforcing struts
- Mast profile Ø 120 mm and 5.5 mm wall thickness
- Roof struts 30 × 55 mm

Frame material

- Aluminium: EN-AW-6063-T66
- Screws and rivets made from stainless steel A4
- Glass-fibre reinforced plastic parts: PA6GF30
- Anodisation:
 - Profile surface finishing
 - High degree of hardness – wear resistance (“scratch-resistant”)
 - Increased corrosion resistance
 - Natural appearance (adaptation to environment)
 - Modern look (luxurious matt)

Frame colour

- Anodised natural matt (standard)
- RAL 7016 powder-coated (no surcharge)
- RAL colours powder-coated (surcharge)
 - Powder coating on anodised profiles providing additional corrosion protection)

Opening principle

- Counter-rotating (telescopic system)
- Patented opening using a toothed belt
- Opened with just 19 turns of the crank

Drive

- With hand crank (detachable)
- With motor (surcharge)

Canopy

- With or without flounce
- 100 % polyacrylic approx. 300 g/m² (spun dyed)
- Replaceable or interchangeable canopies

Wind stability

- Up to 110 km/h (with fixed anchorage)
- Tested in a wind tunnel

Important

- The parasol is delivered as an assembly kit and must be assembled on site

Fixations

74

- Bases / parasol stands / covers
- Ground sockets
- Mounting plates without or with installation height made to measure
- Mounting plates for insulation floors
- Mounting plates for insulation floors with high insulation
- Base plates made to measure

Additional options – Standard accessories

88

- LED lighting system (RGBW)
- Infrared radiant heater
- Motorisation
- BUS systems / connection to the home control system
- Rain gutters
- Side walls
- Protective covers with corset lacing
- Strap systems
- Impact protection
- Anti-theft system (integrated)



Special product solutions – Made to measure

94

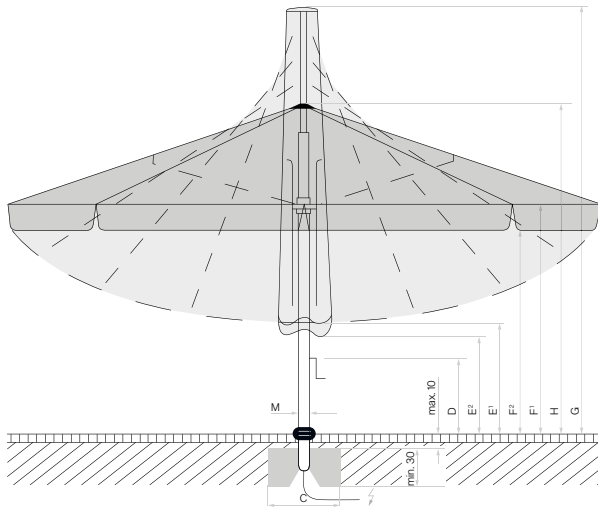
- Special sizes & intermediate measurements (increments 1, 2 & 3)
- Mast extensions & reductions max. + 1000 mm / - 450 mm
- Frame in all RAL colours
- Glatz Green® Special fabric
- Special fabrics (third-party fabrics, PVC & flame retardant)
- Custom flounces & edging strips
- Printing & advertising print



Loose cover max. 10 cm, concrete thickness min. 30 cm (pay attention to frost depth), Guarantee water drainage, Supply line electric.

-  LED positions on the Palazzo Royal with LED
-  Radiant heater positions on the Palazzo Royal with radiant heater

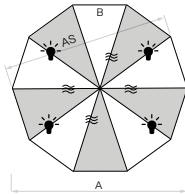

10 parts

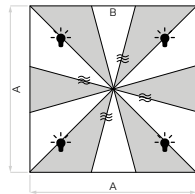

12 parts

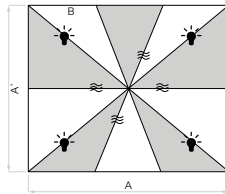

10 parts

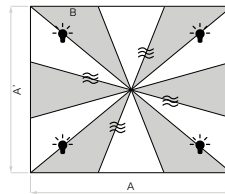

12 parts

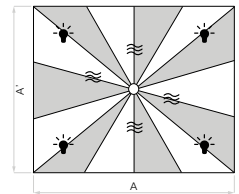

14 parts

Nominal size	Lateral distance	Mast Ø	Area covered	Crank height	Height closed/ with flounce	Clear headroom/ with flounce	Total height	Height open	Foundation	Minimum weight for base	¹⁰ max. wind speed open perm.
cm	cm	cm	m ²	cm	cm	cm	cm	cm	cm	kg	km/h (wind force)
A	AS	M	B	D	E ¹ /E ²	F ¹ /F ²	G	H	C		
Ø 700 ⁷	665	12	36	85	145/120	260/230	502	356	135 × 135	690	80 (9)
Ø 800 ⁷	760	12	49	85	118/93	260/230	527	369	150 × 150	690	70 (8)
500 × 500 ⁸	-	12	25	80	115/90	260/230	470	331	125 × 125	570	110 (11)
550 × 550 ⁸	-	12	30.3	80	96/71	260/230	487	338	125 × 125	690	100 (10)
600 × 600 ⁸	-	12	36	70	85/60	260/230	512	345	135 × 135	690	90 (10)
650 × 650 ⁸	-	12	42.3	70	81/56	260/230	546	364	150 × 150	690	85 (9)
700 × 700 ⁸	-	12	49	70	81/56	260/230	587	394	150 × 150	690	75 (9)
600 × 500 ⁷	-	12	30	85	90/65	260/230	482	339	125 × 125	570	80 (9)
700 × 500 ⁷	-	12	35	70	82/57	260/230	516	350	135 × 135	570	75 (9)
700 × 600 ⁸	-	12	42	70	83/58	260/230	552	373	150 × 150	690	75 (9)
800 × 400 ⁷	-	12	32	70	80/55	260/230	536	378	135 × 135	570	75 (9)
800 × 600 ⁸	-	12	48	70	80/55	260/230	598	419	150 × 150	690	60 (7)

⁷ 10 parts

⁸ 12 parts

⁹ 14 parts

¹⁰ 10 km/h less with flounce

The above measures represent extrapolated average values that may be slightly different on the product (± 2% ± 5 cm).

If a minimum height underneath is required, this must be agreed with Glatz.

The measures of the height are determined by the M16 ground socket. If one of the offered bases is used, these measures change only slightly.

The max. wind speed limits as per our separate list apply only in the presence of a fix ground anchorage.

In the presence of several parasols, the min. distance between one parasol and another and between parasols and walls shall be 30 cm.

Opening and closing using a battery-operated drill is not permitted.



- 1 Rivage Hôtel & Spa – Ancey, FR
- 2 MY HOME | MY HOTEL – Rosenheim, DE
- 3 Landgoed Lauswolt – Beetsterzwaag, NL
- 4 Andaz am Belvedere – Vienna, AT
- 5 Hyatt Restaurant Babel – Zurich, CH



PALAZZO® Noblesse

The giant parasol for the ambitious



Unique selling proposition

- Palazzo line design language: uniform design of the models Royal, Noblesse and Style
- Continuous mast profile down to the floor covering (internal support tube & tip-over hinge)
- Counter-rotating opening principle (with crank or motor):
Opened with just 12 turns of the crank (patented)
High closing height (no need to move the furniture)
- 95 km/h wind stability at size 400 × 400 cm
- Top quality material selection
- LED lighting system integrated into the struts
- Professional additional options (Heating, rain gutters, ...)
- Special product solutions (Sizes, frame, fabrics, ...)

Places of use

- Large area outdoors
- Terraces & rooftops
- Public spaces & parks
- Corrosive environments





Basic model

Frame

- 8, 10 or 12 parts made from anodised aluminium
- Anti-rotation mast including reinforcing struts
- Mast profile Ø 105 mm and 4.5 mm wall thickness
- Roof struts 23 × 50 mm / 23 × 40 mm

Frame material

- Aluminium: EN-AW-6063-T66
- Screws and rivets made from stainless steel A4
- Glass-fibre reinforced plastic parts: PA6GF30
- Anodisation:
 - Profile surface finishing
 - High degree of hardness – wear resistance (“scratch-resistant”)
 - Increased corrosion resistance
 - Natural appearance (adaptation to environment)
 - Modern look (luxurious matt)

Frame colour

- Anodised natural matt (standard)
- RAL 7016 powder-coated (no surcharge)
- RAL colours powder-coated (surcharge)
 - Powder coating on anodised profiles
 - (providing additional corrosion protection)

Opening principle

- Counter-rotating (telescopic system)
- Patented opening using a toothed belt
- Opened with just 12 turns of the crank

Drive

- With hand crank (detachable)
- With motor (surcharge)

Canopy

- With or without flounce
- Adjustable (adjustable strut extensions)
- 100 % polyacrylic approx. 300 g/m² (spun dyed)
- Replaceable or interchangeable canopies

Wind stability

- Up to 95 km/h (with fixed anchorage)
- Tested in a wind tunnel

Fixations

74

- Bases / parasol stands / covers
- Ground sockets
- Mounting plates without or with installation height made to measure
- Mounting plates for insulation floors
- Mounting plates for insulation floors with high insulation
- Base plates made to measure

Additional options – Standard accessories

88

- LED lighting system (RGBW)
- Infrared radiant heater
- Motorisation
- BUS systems / connection to the home control system
- Rain gutters
- Side walls
- Protective covers with corset lacing
- Strap systems
- Impact protection
- Anti-theft system (integrated)



Special product solutions – Made to measure

94

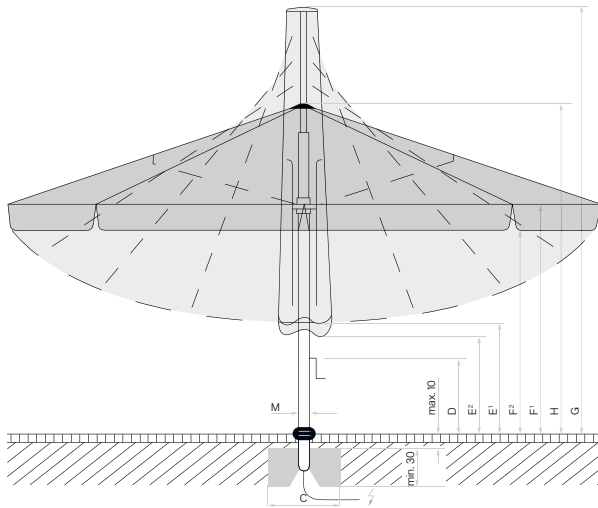
- Special sizes & intermediate measurements (increments 1, 2 & 3)
- Mast extensions & reductions
 - max. + 1000 mm / - 500 mm
- Frame in all RAL colours
- Glatz Green® Special fabric
- Special fabrics (third-party fabrics, PVC & flame retardant)
- Custom flounces & edging strips
- Printing & advertising print



Loose cover max. 10 cm, concrete thickness min. 30 cm (pay attention to frost depth), Guarantee water drainage, Supply line electric.

-  LED positions on the Palazzo Noblesse with LED
-  Radiant heater positions on the Palazzo Noblesse with radiant heater

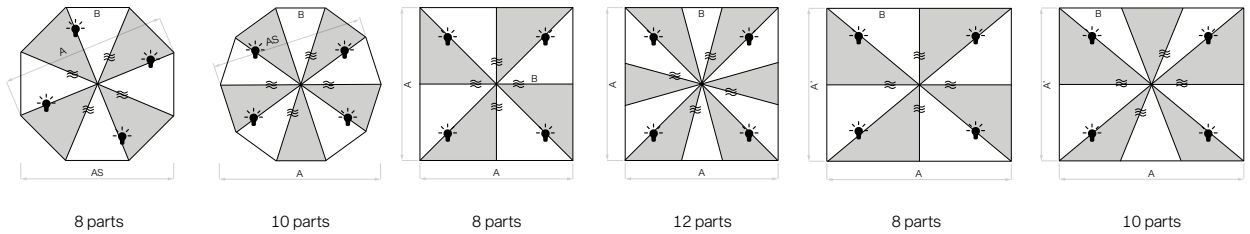

Nominal size	Lateral distance	Mast Ø	Area covered	Crank height	Height closed/ with flounce	Clear headroom/ with flounce	Total height	Height open	Foundation	Minimum weight for base	¹⁰ max. wind speed open perm.
cm	cm	cm	m ²	cm	cm	cm	cm	cm	cm	kg	km/h (wind force)
A	AS	M	B	D	E¹/E²	F¹/F²	G	H	C		
Ø 450 ⁶	416	10.5	14.3	85	167/142	235/210	369	299	100×100	240	85 (9)
Ø 500 ⁶	462	10.5	17.7	85	169/144	235/210	392	305	100×100	240	75 (9)
Ø 600 ⁷	571	10.5	25.5	85	141/116	235/210	447	318	125×125	430	80 (9)
Ø 700 ⁷	665	10.5	36.8	85	103/78	235/210	460	331	135×135	570	70 (8)
400×400 ⁶	-	10.5	16	85	121/96	235/210	404	294	100×100	310	95 (10)
450×450 ⁶	-	10.5	20.3	85	98/73	235/210	417	300	120×120	430	80 (9)
500×500 ⁶	-	10.5	25	75	84/59	235/210	439	307	120×120	430	70 (8)
500×500 ⁸	-	10.5	25	75	84/59	235/210	439	307	125×125	430	85 (9)
550×550 ⁸	-	10.5	30.3	65	80/55	235/210	472	318	125×125	570	75 (9)
600×600 ⁸	-	10.5	36	65	81/56	235/210	512	344	135×135	570	65 (8)
450×350 ⁶	-	10.5	15.8	80	112/87	235/210	397	294	100×100	240	85 (9)
500×250 ⁶	-	10.5	12.5	85	91/66	235/210	374	310	100×100	240	90 (10)
500×400 ⁶	-	10.5	20	80	101/76	235/210	422	301	100×100	310	70 (8)
550×450 ⁷	-	10.5	24.8	75	85/60	235/210	442	308	120×120	430	75 (9)
600×300 ⁷	-	10.5	18	85	81/56	235/210	418	307	100×100	310	80 (9)
600×400 ⁷	-	10.5	24	75	81/56	235/210	443	309	135×135	430	75 (9)
600×500 ⁷	-	10.5	30	65	82/57	235/210	476	321	135×135	430	70 (8)

⁶ 8 parts, ⁷ 10 parts, ⁸ 12 parts, ¹⁰ 10 km/h less with flounce

The above measures represent extrapolated average values that may be slightly different on the product (± 2% ± 5 cm).

If a minimum height underneath is required, this must be agreed with Glatz.

The measures of the height are determined by the M4 / M8 ground socket. If one of the offered bases is used, these measures change only slightly.

The max. wind speed limits as per our separate list apply only in the presence of a fix ground anchorage.

In the presence of several parasols, the min. distance between one parasol and another and between parasols and walls shall be 25 cm.

Opening and closing using a battery-operated drill is not permitted.



- 1 Place de Paris – Quebec, CA
- 2 Hotel Adapura – Wagrain, AT
- 3 Hotel Märthof – Basel, CH
- 4 Thon Hotel Lofoten – Svolvær, NO
- 5 Rooftop Bar & Restaurant – Lille, FR



PALAZZO® Style
The stylish parasol



Unique selling proposition

- Palazzo line design language: uniform design of the models Royal, Noblesse and Style
- Continuous mast profile down to the floor covering (internal support tube & tip-over hinge)
- Counter-rotating opening principle (with crank or motor):
Opened with just 9 turns of the crank (patented)
High closing height (no need to move the furniture)
- 110 km/h wind stability at size 300 × 300 cm
- Top quality material selection
- LED lighting system integrated into the struts
- Professional additional options (Heating, rain gutters, ...)
- Special product solutions (Sizes, frame, fabrics, ...)

Places of use

- Small area outdoors
- Terraces & rooftops
- Public spaces & parks
- Corrosive environments





Basic model

Frame

- 8 parts made from anodised aluminium
- Anti-rotation mast including reinforcing struts
- Mast profile Ø 105 mm and 4.5 mm wall thickness
- Roof struts 23 × 40 mm

Frame material

- Aluminium: EN-AW-6063-T66
- Screws and rivets made from stainless steel A4
- Glass-fibre reinforced plastic parts: PA6GF30
- Anodisation:
 - Profile surface finishing
 - High degree of hardness – wear resistance (“scratch-resistant”)
 - Increased corrosion resistance
 - Natural appearance (adaptation to environment)
 - Modern look (luxurious matt)

Frame colour

- Anodised natural matt (standard)
- RAL 7016 powder-coated (no surcharge)
- RAL colours powder-coated (surcharge)
 - Powder coating on anodised profiles
 - (providing additional corrosion protection)

Opening principle

- Counter-rotating (telescopic system)
- Patented opening using a toothed belt
- Opened with just 9 turns of the crank

Drive

- With hand crank (detachable)
- With motor (surcharge)

Canopy

- With or without flounce
- Adjustable (adjustable strut extensions)
- 100 % polyacrylic approx. 300 g/m² (spun dyed)
- Replaceable or interchangeable canopies

Wind stability

- Up to 110 km/h (with fixed anchorage)
- Tested in a wind tunnel

Fixations

74

- NEW Bases / parasol stands / covers
- Ground sockets
- Mounting plates without or with installation height made to measure
- Mounting plates for insulation floors
- Mounting plates for insulation floors with high insulation
- Base plates made to measure

Additional options – Standard accessories

88

- LED lighting system (RGBW)
- Infrared radiant heater
- Motorisation
- BUS systems / connection to the home control system
- Rain gutters
- Side walls
- Protective covers with corset lacing
- Strap systems
- Impact protection
- Anti-theft system (integrated)



Special product solutions – Made to measure

94

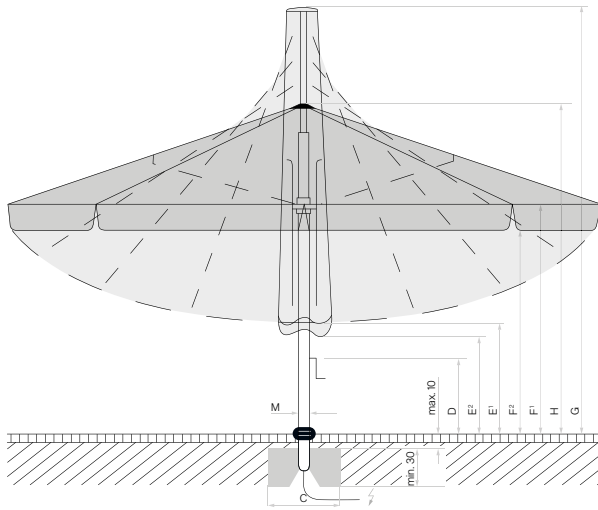
- Special sizes & intermediate measurements (increments 1 & 2)
- Mast extensions & reductions
 - max. + 1000 mm / - 500 mm
- Frame in all RAL colours
- Glatz Green® Special fabric
- Special fabrics (third-party fabrics, PVC & flame retardant)
- Custom flounces & edging strips
- Printing & advertising print



Loose cover max. 10 cm, concrete thickness min. 30 cm (pay attention to frost depth), Guarantee water drainage, Supply line electric.

-  LED positions on the Palazzo Style with LED
-  Radiant heater positions on the Palazzo Style with radiant heater

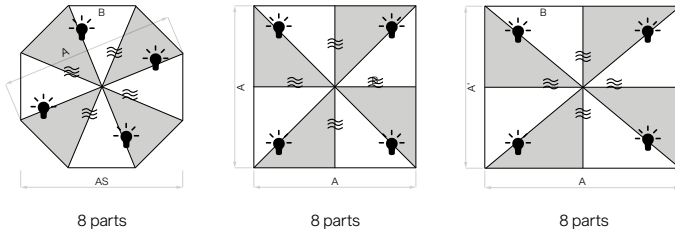

Nominal size	Lateral distance	Mast Ø	Area covered	Slide distance	Height closed/ with flounce	Clear headroom/ with flounce	Total height	Height open	Foundation	Minimum weight for base	¹⁰ max. wind speed open perm.
cm	cm	cm	m ²	cm	cm	cm	cm	cm	cm	kg	km/h (wind force)
A	AS	M	B	D	E¹/E²	F¹/F²	G	H	C		
Ø 350	325	10.5	8.7	85	179/154	235/210	356	285	80×80	180	115 (11)
Ø 400	370	10.5	11.3	85	176/151	235/210	378	292	80×80	180	90 (10)
Ø 450	415	10.5	14.3	85	178/153	235/210	406	299	80×80	180	75 (9)
Ø 500	460	10.5	17.7	85	169/144	235/210	423	305	100×100	240	65 (8)
Ø 600	554	10.5	25.5	85	136/111	235/210	455	319	120×120	310	55 (7)
300×300	-	10.5	9	85	142/117	235/210	353	280	80×80	180	110 (11)
350×350	-	10.5	12.3	85	124/99	235/210	371	287	100×100	240	95 (10)
400×400	-	10.5	16	85	121/96	235/210	405	294	100×100	240	80 (9)
450×450	-	10.5	20.3	80	103/78	235/210	422	301	100×100	310	70 (8)
350×250	-	10.5	8.8	85	123/98	235/210	337	281	80×80	180	100 (10)
350×300	-	10.5	10.5	85	133/108	235/210	362	284	80×80	180	95 (10)
400×200	-	10.5	8	85	100/75	235/210	322	283	80×80	180	95 (10)
400×300	-	10.5	12	85	117/92	235/210	366	288	80×80	180	80 (9)
450×350	-	10.5	15.8	85	109/84	235/210	394	295	100×100	240	75 (9)

¹⁰ 10 km/h less with flounce

The above measures represent extrapolated average values that may be slightly different on the product (± 2% ± 5 cm).

If a minimum height underneath is required, this must be agreed with Glatz.

Height dimensions are based on ground socket M4. These differ slightly depending on the type of base. Except for base M4, 180 kg plus 15.5 cm.

The max. wind speed limits as per our separate list apply only in the presence of a fix ground anchorage.

In the presence of several parasols, the min. distance between one parasol and another and between parasols and walls shall be 25 cm.

Opening and closing using a battery-operated drill is not permitted.

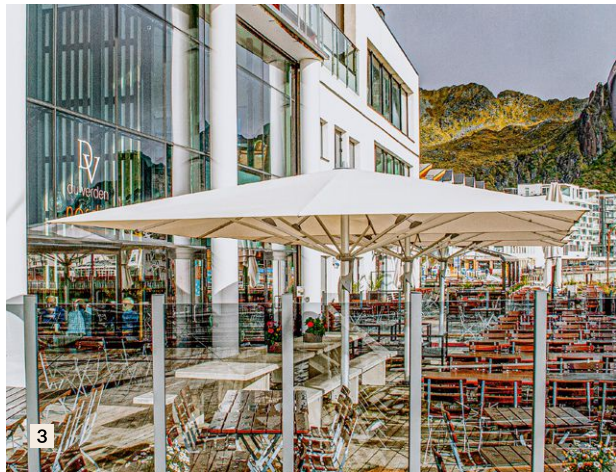

- 1 A-ROSA Resort – Sylt, DE
- 2 Humboldt Forum – Berlin, DE
- 3 DV du verden – Svolvær, NO
- 4 US-MEX Terraza – Kreuzlingen, CH
- 5 KOBALT Club Royal – Dresden, DE



CASTELLO® Pro

The versatile allrounder



Unique selling proposition

- F-line design language: Harmonises with the Fortello, Fortero and Fortino Riviera models
- Continuous mast profile down to the floor covering (internal support tube)
- Counter-rotating opening principle:
Quick and easy operation using tensioning lever
High closing height (no need to move the furniture)
- 100 km/h wind stability at size 300 × 300 cm
- Top quality material selection
- LED lighting system integrated into the struts
- Professional additional options (Heating, rain gutters, ...)
- Special product solutions (Sizes, frame, fabrics, ...)
- Lockable tensioning lever against unauthorised use

Places of use

- Large area outdoors
- Small area outdoors
- Terraces & rooftops
- Public spaces & parks
- Corrosive environments





Basic model

Frame

- 8 parts made from anodised aluminium
- Profiled and anti-rotation mast
- Mast profile Ø 90 mm and 3.2 mm wall thickness
- Roof struts 20 × 33 mm

Frame material

- Aluminium: EN-AW-6063-T66
- Screws and rivets made from stainless steel A4
- Glass-fibre reinforced plastic parts: PA6GF30
- Anodisation:
 - Profile surface finishing
 - High degree of hardness – wear resistance (“scratch-resistant”)
 - Increased corrosion resistance
 - Natural appearance (adaptation to environment)
 - Modern look (luxurious matt)

Frame colour

- Anodised natural matt (standard)
- RAL 7016 powder-coated (no surcharge)
- RAL colours powder-coated (surcharge)
 - Powder coating on anodised profiles
 - (providing additional corrosion protection)

Opening principle

- Counter-rotating (telescopic system)
- Fast opening thanks to slide and tensioning lever

Canopy

- With or without flounce
- Self-tautening thanks to the flexible strut ends
- 100 % polyacrylic approx. 300 g/m² (spun dyed)
- Replaceable or interchangeable canopies

Wind stability

- Up to 100 km/h (with fixed anchorage)
- Tested in a wind tunnel

Fixations

74

- NEW Bases / parasol stands / covers
- Ground sockets
- Mounting plates without or with installation height made to measure
- Mounting plates for insulation floors
- Mounting plates for insulation floors with high insulation
- Base plates made to measure

Additional options – Standard accessories

88

- LED lighting system (RGBW)
- Infrared radiant heater
- Rain gutters
- Side walls
- Protective covers with corset lacing
- Strap systems
- Impact protection
- Anti-theft system
- Lockable tensioning lever

Special product solutions – Made to measure

94

- Special sizes & intermediate measurements (increment 1)
- Mast extensions & reductions
 - max. + 800 mm / - 800 mm
- Frame in all RAL colours
- Glatz Green® Special fabric
- Special fabrics (third-party fabrics, PVC & flame retardant)
- Custom flounces & edging strips
- Printing & advertising print

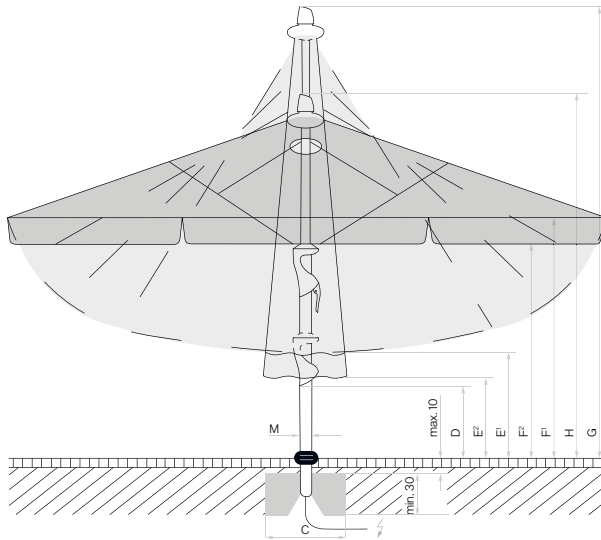

Loose cover max. 10 cm, concrete thickness min. 30 cm (pay attention to frost depth), Guarantee water drainage, Supply line electric.

💡 LED positions on the Castello Pro with LED

⊞ Radiant heater positions on the Castello Pro with radiant heater

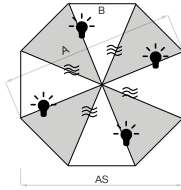

8 parts

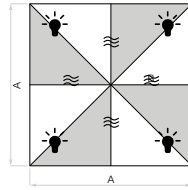

8 parts

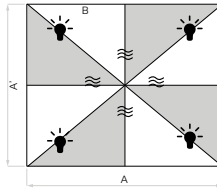

8 parts

Nominal size	Lateral distance	Mast Ø	Area covered	Height of slide	Height closed/ with flounce	Clear headroom/ with flounce	Total height	Height open	Foundation	Minimum weight for base	¹⁰ max. wind speed open perm.
cm	cm	cm	m ²	cm	cm	cm	cm	cm	cm	kg	km/h (wind force)
A	AS	M	B	D	E'/E''	F'/F''	G	H	C		
Ø 350	325	9	8.7	113	162/137	225/200	342	280	80×80	180	100 (10)
Ø 400	370	9	11.3	105	154/129	225/200	360	286	80×80	180	90 (10)
Ø 450	415	9	14.3	97	146/121	225/200	377	293	90×90	180	75 (9)
Ø 500	462	9	17.7	90	137/112	225/200	394	299	100×100	240	70 (8)
Ø 550	510	9	21.4	83	129/104	225/200	412	306	120×120	310	65 (8)
Ø 600	554	9	25.5	74	120/95	225/200	429	313	120×120	310	55 (7)
300×300	-	9	9	89	127/102	225/200	341	276	80×80	180	100 (10)
350×350	-	9	12.3	73	114/89	225/200	365	283	100×100	240	85 (9)
400×400	-	9	16	59	100/75	225/200	387	290	100×100	240	75 (9)
450×450	-	9	20.3	55	89/64	225/200	412	298	100×100	310	65 (8)
500×500	-	9	25	50	82/57	225/200	440	305	120×120	310	60 (7)
350×300	-	9	10.5	78	120/95	225/200	354	280	80×80	180	90 (10)
400×300	-	9	12	80	107/82	225/200	360	283	90×90	180	80 (9)
450×350	-	9	15.8	65	95/70	225/200	384	291	100×100	240	75 (9)
500×400	-	9	20	53	82/57	225/200	407	298	100×100	310	65 (8)
550×450	-	9	24.8	51	82/57	225/200	442	305	120×120	310	60 (7)

¹⁰ 10 km/h less with flounce

The above measures represent extrapolated average values that may be slightly different on the product (± 2% ± 5 cm).

If a minimum height underneath is required, this must be agreed with Glatz.

Height dimensions are based on ground socket M4. These differ slightly depending on the type of base. Except for base M4, 180 kg plus 15.5 cm.

The max. wind speed limits as per our separate list apply only in the presence of a fix ground anchorage.

In the presence of several parasols, the min. distance between one parasol and another and between parasols and walls shall be 25 cm.

Centre pole parasols

F Line

The dimensions are not too big and not too small – that's why the F line with the models Fortino Riviera, Fortero and Fortello is in such high demand in the contract sector. This model range is ideal for compact and contorted outdoor areas; arranged as a group, they can easily shade larger areas while speaking the same design language.

Handling and operation is child's play. The opposing opening principle ensures high efficiency: simply pull the tensioning lever downwards and engage in the runner. The well thought-out telescopic system with its high closing heights is especially convenient as it does not touch furniture or crockery.

The Fortello is perfect for spending time outdoors in the late evening or at night. It is available with LED lighting, without a tangle of cables and without any power supply lines required on site. The rechargeable Glatz battery pack provides dimmable LED light for up to 10 hours.

Our giant parasol Castello Pro is also often the top choice when it comes to custom requests. It harmonises perfectly with the F line and ensures a uniform appearance at the property when combined.

ALU-SMART

The name says it all: simple and practical operation, many useful functions and a modern design. With its sizes, it easily adapts to compact and tight spaces and, owing to its height adjustment and tilting, provides shade to meet your preferences, even when the sun is at a low angle.



FL FORTELLO®
The large-size windproof parasol

36

- 250 to 400 cm
- Max. 100 km/h wind stability
- Counter-rotating opening principle
- Quick and easy operation using tensioning lever
- Optionally available with integrated LED lighting
- Rechargeable Glatz battery pack



FR FORTERO®
The medium-size windproof parasol

40

- 200 to 400 cm
- Max. 70 km/h wind stability
- Counter-rotating opening principle
- Quick and easy operation using tensioning lever
- Osyrion Spot battery-powered LED light with remote
- Optional bistro table available (attached to the mast)



FI FORTINO® Riviera
The compact windproof parasol

44

- 200 to 300 cm
- Max. 80 km/h wind stability
- Counter-rotating opening principle
- Quick and easy operation using tensioning lever
- Corrosion resistant plastic components
- Osyrion Spot battery-powered LED light with remote



AS ALU-SMART
The small and adaptable parasol

48

- 150 to 300 cm
- Max. 65 km/h wind stability
- Easy to open by pressing the slide
- Continuous height adjustment
- Tilt function by activating the tilt joint
- Osyrion Spot battery-powered LED light with remote



1



2



3



4



5

- 1 Nature resort Schindelbruch – Südharz, DE
- 2 Bistrot Pierre 1994 – Swansea, UK
- 3 One & Only Royal Mirage – Drift Beach Club – Dubai, AE
- 4 La MAISON Bleue – Courseulles sur Mer, FR
- 5 Alpine inn Bollenwees – Brülisau, CH



FORTELLO®
The large-size windproof parasol



Unique selling proposition

- F-line design language: uniform design of the models Fortello, Fortero and Fortino Riviera
- Continuous mast profile down to the floor covering (internal support tube)
- Counter-rotating opening principle:
Quick and easy operation using tensioning lever
High closing height (no need to move the furniture)
- 100 km/h wind stability at size 300 × 300 cm
- Top quality material selection
- LED lighting integrated into the struts
- Rechargeable Glatz battery pack (no power supply)
- Quickship program available

Places of use

- Small area outdoors
- Terraces & rooftops
- Public spaces & parks





Basic model**Frame**

- 8 parts made from anodised aluminium
- Profiled two-part mast
- Mast profile Ø 67 mm and 3 mm wall thickness
- Roof struts 20 × 33 mm

Frame material

- Aluminium: EN-AW-6063-T5
- Screws and rivets made from stainless steel A2
- Anodisation:
 - Profile surface finishing
 - High degree of hardness – wear resistance (“scratch-resistant”)
 - Increased corrosion resistance
 - Natural appearance (adaptation to environment)
 - Modern look (luxurious matt)

Frame colour

- Anodised natural matt

Opening principle

- Counter-rotating (telescopic system)
- Fast opening thanks to slide and tensioning lever

Canopy

- Without flounce (flounce for a surcharge)
- Self-tautening thanks to the flexible strut ends
- Available in 3 fabric qualities:
 - 100 % polyacrylic approx. 300 g/m² (spun dyed)
 - 100 % polyester approx. 250 g/m² (spun dyed)
 - 100 % polyester approx. 220 g/m² (piece dyed)
- Replaceable or interchangeable canopies

Wind stability

- Up to 100 km/h (with fixed anchorage)
- Tested in a wind tunnel

Fixations

74

- NEW Bases / parasol stands / covers
- Ground sockets
- Mounting plates without or with installation height made to measure
- Mounting plates for insulation floors
- Mounting plates for insulation floors with high insulation
- Base plates made to measure

Additional options – Standard accessories

88

- LED lighting with battery pack (Not suitable for corrosive environments)
- Protective cover

Special product solutions – Made to measure

94

- Mast extensions & reductions
 - max. + 300 mm / - 300 mm
- Glatz Green® Special fabric
- Special fabrics (third-party fabrics, flame retardant)
- Custom flounces & edging strips
- Printing & advertising print

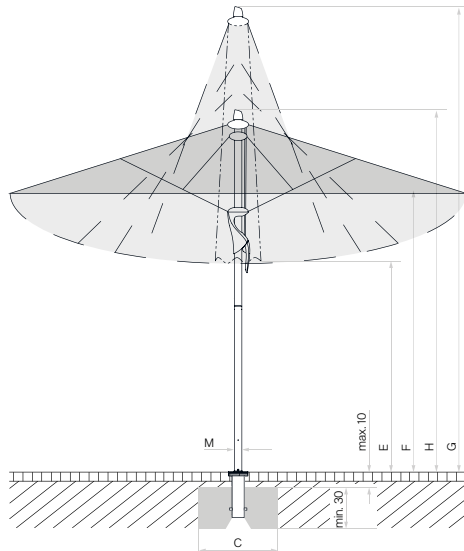

Loose cover max. 10 cm, concrete thickness
min. 30 cm (pay attention to frost depth), Guarantee
water drainage

 LED positions on the Fortello LED

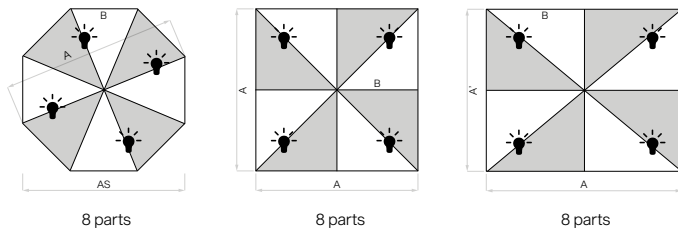

Nominal size	Lateral distance	Mast Ø	Area covered	Height closed	Clear headroom	Total height	Height open	Foundation	Minimum weight for base	max. wind speed open perm.
cm	cm	cm	m ²	cm	cm	cm	cm	cm	kg	km/h (Bft.)
A	AS	M	B	E	F	G	H	C		
Ø 400	370	6.7	11.3	135	215	345	280	80×80	120	85 (9)
300×300	-	6.7	9	125	215	345	270	80×80	120	100 (10)
350×350	-	6.7	12.3	110	215	365	280	80×80	120	85 (9)
400×400	-	6.7	16.0	95	215	385	290	100×100	180	75 (9)
400×300	-	6.7	12	130	215	375	290	80×80	120	85 (9)

The listed measures represent extrapolated average values that may be slightly different on the product ($\pm 2\% \pm 5$ cm).

The height dimensions are based on the ground socket M4. With the base M4, 120 kg these vary by plus 11.5 cm and with the base M4, 180 kg by plus 15.5 cm.

Using PX ground socket with adapter on M4 leaves an additional 10.5 cm.

The max. wind speed limits as per our separate list apply only in the presence of a fix ground anchorage.

In the presence of several parasols, the minimum distance between one parasol and another and between parasols and walls shall be 20 cm.



- 1 Victoria Jungfrau Grand Hotel & Spa – Interlaken, CH
- 2 Pfalzblick Forest Spa Resort – Dahn, DE
- 3 Beach hotel at Weissensee – Neusach, AT
- 4 Iberostar Grand Portals Nous – Mallorca, ES
- 5 Darwins Café – Lisbon, PT



FORTERO®

The medium-size windproof parasol



Unique selling proposition

- F-line design language: uniform design of the models Fortello, Fortero and Fortino Riviera
- Counter-rotating opening principle:
Quick and easy operation using tensioning lever
High closing height (no need to move the furniture)
- 70 km/h wind stability at size 250 × 250 cm
- Top quality material selection
- Osyrion Spot battery-powered LED light with remote
- Optional bistro table (attached to the mast)
- Quickship program available

Places of use

- Small area outdoors
- Public spaces & parks

**Basic model****Frame**

- 8 parts made from anodised aluminium
- Profiled two-part mast
- Mast profile Ø 55 mm and 2.5 mm wall thickness
- Roof struts 20 × 26 mm

Frame material

- Aluminium: EN-AW-6063-T5
- Screws and rivets made from stainless steel A2
- Anodisation:
 - Profile surface finishing
 - High degree of hardness – wear resistance (“scratch-resistant”)
 - Increased corrosion resistance
 - Natural appearance (adaptation to environment)
 - Modern look (luxurious matt)

Frame colour

- Anodised natural matt

Opening principle

- Counter-rotating (telescopic system)
- Fast opening thanks to slide and tensioning lever

Canopy

- Without flounce (flounce for a surcharge)
- Self-tautening thanks to the flexible strut ends
- Available in 3 fabric qualities:
 - 100 % polyacrylic approx. 300 g/m² (spun dyed)
 - 100 % polyester approx. 250 g/m² (spun dyed)
 - 100 % polyester approx. 220 g/m² (piece dyed)
- Replaceable or interchangeable canopies

Wind stability

- Up to 70 km/h (with fixed anchorage)
- Tested in a wind tunnel

Fixations

74

- NEW Bases / parasol stands / covers
- Ground sockets
- Mounting plates without or with installation height made to measure
- Mounting plates for insulation floors
- Mounting plates for insulation floors with high insulation
- Base plates made to measure

Additional options – Standard accessories

88

- Osyrium Spot battery-powered LED light, removable
- Protective cover

Special product solutions – Made to measure

94

- Glatz Green® Special fabric
- Special fabrics (third-party fabrics, flame retardant)
- Custom flounces & edging strips
- Printing & advertising print

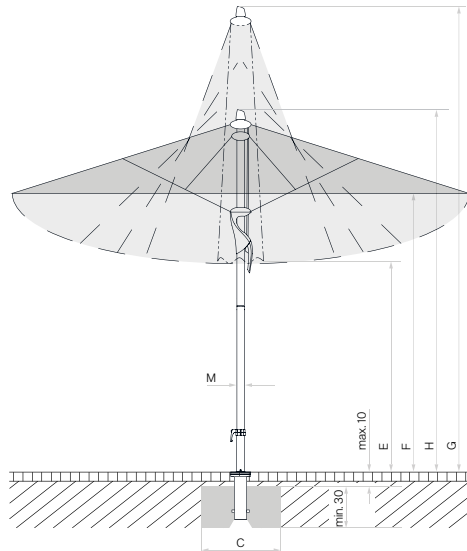

Loose cover max. 10 cm, concrete thickness
min. 30 cm (pay attention to frost depth), Guarantee
water drainage

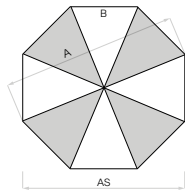

8 parts

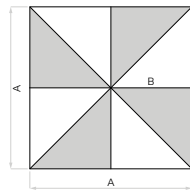

8 parts

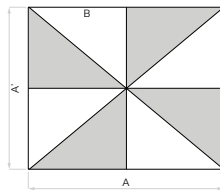

8 parts

Nominal size	Lateral distance	Mast Ø	Area covered	Height closed	Clear headroom	Total height	Height open	Foundation	Minimum weight for base	max. wind speed open perm.
cm	cm	cm	m ²	cm	cm	cm	cm	cm	kg	km/h (wind force)
A	AS	M	B	E	F	G	H	C		
Ø 350	325	5.5	8.7	125	205	310	260	70×70	90	55 (7)
250×250	-	5.5	6.3	110	205	295	255	70×70	70	70 (8)
300×300	-	5.5	9.0	95	205	315	260	70×70	90	60 (7)
350×350	-	5.5	12.3	85	205	345	270	80×80	120	50 (7)
300×200	-	5.5	6.0	120	205	310	260	70×70	70	60 (7)
350×250	-	5.5	8.8	110	205	335	270	70×70	90	55 (7)

The listed measures represent extrapolated average values that may be slightly different on the product ($\pm 2\% \pm 5$ cm).

Height dimensions are based on ground socket M4. If one of the offered bases is used, these measures raise by 11.5–15.5 cm.

Using PX ground socket with connecting tube leaves an additional 10.5 cm.

The max. wind speed limits as per our separate list apply only in the presence of a fix ground anchorage.

In the presence of several parasols, the minimum distance between one parasol and another and between parasols and walls shall be 20 cm.



- 1 Pfalzblick Forest Spa Resort – Dahn, DE
- 2 DAS GOLDBERG – Bad Hofgastein, AT
- 3 Campus Hotel – Hertenstein, CH
- 4 AURORA Restaurant – Zurich, CH
- 5 Maistra Boutique Hotel Alhambra – Mali Losinj, HR



FORTINO® Riviera

The compact windproof parasol



Unique selling proposition

- F-line design language: uniform design of the models Fortello, Fortero and Fortino Riviera
- Modern look thanks to extra flat roof of the parasol
- Counter-rotating opening principle:
Quick and easy operation using tensioning lever
High closing height (no need to move the furniture)
- 80 km/h wind stability at size Ø 250 cm
- Top quality material selection
- Osyrion Spot battery-powered LED light with remote
- Quickship program available

Places of use

- Small area outdoors
- Terraces & rooftops
- Public spaces & parks
- Corrosive environments



Basic model

Frame

- 8 parts made from anodised aluminium
- Profiled two-part pole
- Pole profile Ø 38.4 mm and 2 mm wall thickness
- Roof struts 14 × 20 mm

Frame material

- Aluminium: EN-AW-6063-T5
- Screws and rivets made from stainless steel A4
- Glass-fibre reinforced plastic parts: PA6GF30
- Anodisation:
 - Profile surface finishing
 - High degree of hardness – wear resistance (“scratch-resistant”)
 - Increased corrosion resistance
 - Natural appearance (adaptation to environment)
 - Modern look (luxurious matt)

Frame colour

- Anodised natural matt

Opening principle

- Counter-rotating (telescopic system)
- Fast opening thanks to slide and tensioning lever

Canopy

- Without flounce (flounce for a surcharge)
- Self-tautening thanks to the flexible strut ends
- Available in 3 fabric qualities:
 - 100 % polyacrylic approx. 300 g/m² (spun dyed)
 - 100 % polyester approx. 250 g/m² (spun dyed)
 - 100 % polyester approx. 220 g/m² (piece dyed)
- Replaceable or interchangeable canopies

Wind stability

- Up to 80 km/h (with fixed anchorage)
- Tested in a wind tunnel

Fixations

74

- NEW Bases / parasol stands
 - Ground sockets
 - Mounting plates without or with installation height made to measure*
 - Mounting plates for insulation floors*
 - Mounting plates for insulation floors with high insulation*
 - Base plates made to measure*
- * Adapter required

Additional options – Standard accessories

88

- Osyrion Spot battery-powered LED light, removable
- Protective cover

Special product solutions – Made to measure

94

- Glatz Green® Special fabric
- Special fabrics (third-party fabrics, flame retardant)
- Custom flounces & edging strips
- Printing & advertising print

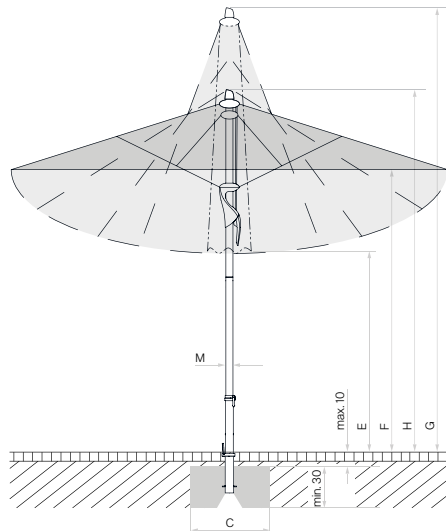

Loose cover max. 10 cm, concrete thickness
min. 30 cm (pay attention to frost depth), Guarantee
water drainage

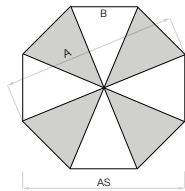

8 parts

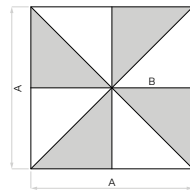

8 parts

Nominal size	Lateral distance	Pole Ø	Area covered	Height closed	Clear headroom	Total height	Height open	Foundation	Minimum weight for base	max. wind speed open perm.
cm	cm	cm	m ²	cm	cm	cm	cm	cm	kg	km/h (wind force)
A	AS	M	B	E	F	G	H	C		
Ø 250	230	3.8	4.4	150	205	285	240	60×60	55	80 (9)
Ø 300	275	3.8	6.4	140	205	300	245	70×70	70	60 (7)
200×200	-	3.8	4.0	135	205	285	240	60×60	55	70 (8)
240×240	-	3.8	5.8	115	205	295	245	70×70	70	60 (7)

The listed measures represent extrapolated average values that may be slightly different on the product ($\pm 2\% \pm 5$ cm).

Height dimensions are based on ground socket BT. These vary slightly depending on the type of base. Except for steel base minus 5 cm.

The max. wind speed limits as per our separate list apply only in the presence of a fix ground anchorage.

In the presence of several parasols, the minimum distance between one parasol and another and between parasols and walls shall be 20 cm.



1



2



3



4



5

- 1 Design Hotel Tyrol – Parcines, IT
- 2 Pfalzblick Forest Spa Resort – Dahn, DE
- 3 Le Régina Hotel & Spa – Biarritz, FR
- 4 DAS EDELWEISS Mountain Resort – Salzburg, AT
- 5 Culinarium Alpinum – Stans, CH



ALU-SMART

The small and adaptable parasol



Unique selling proposition

- Modern design language thanks to extra flat parasol roof
- Easy to open by pressing the slide
- Continuous height adjustment
- Tilt joint to tilt the parasol roof
- 65 km/h wind stability at size Ø 220 cm
- Top quality material selection
- Osyrion Spot battery-powered LED light with remote
- Quickship program available

Places of use

- Small area outdoors
- Corrosive environments



ALU-SMART

The small and adaptable parasol

Basic model

Frame

- 6 or 8 parts made from anodised natural aluminium
- Profiled two-part pole
- Upper pole profile Ø 38.4 mm / 1.2 mm wall thickness
- Lower pole profile Ø 35 mm / 1.5 mm wall thickness
- Roof struts 14 × 20 mm

Frame material

- Aluminium: EN-AW-6063-T5
- Screws and rivets made from stainless steel A2
- Anodisation:
 - Profile surface finishing
 - High degree of hardness – wear resistance (“scratch-resistant”)
 - Increased corrosion resistance
 - Natural appearance (adaptation to environment)
 - Modern look (luxurious matt)

Frame colour

- Anodised natural matt

Opening principle & functions

- Push-up function (press the slide)
- Continuous height adjustment
- Parasol roof can be tilted using the tilt joint

Canopy

- Without flounce (flounce for a surcharge)
- Self-tautening thanks to the flexible strut ends
- Available in 3 fabric qualities:
 - 100 % polyacrylic approx. 300 g/m² (spun dyed)
 - 100 % polyester approx. 250 g/m² (spun dyed)
 - 100 % polyester approx. 220 g/m² (piece dyed)
- Replaceable or interchangeable canopies

Wind stability

- Up to 65 km/h (with fixed anchorage)
- Tested in a wind tunnel

Fixations

74

- NEW Bases / parasol stands
- Ground sockets

Additional options – Standard accessories

88

- Osyrion Spot battery-powered LED light, removable
- Protective cover

Special product solutions – Made to measure

94

- Glatz Green® Special fabric
- Special fabrics (third-party fabrics, flame retardant)
- Custom flounces & edging strips
- Printing & advertising print

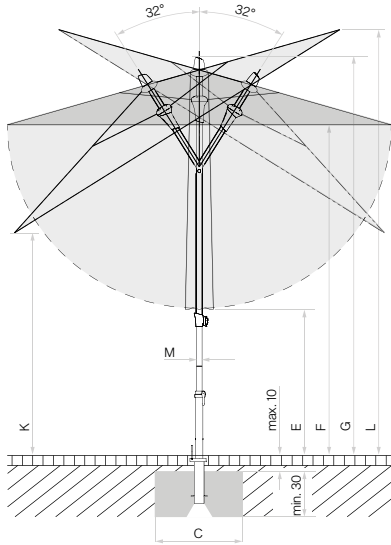

Loose cover max. 10 cm, concrete thickness
min. 30 cm (pay attention to frost depth), Guarantee
water drainage

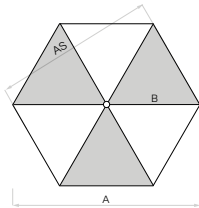

6 parts

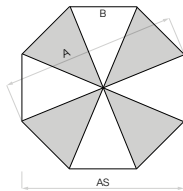

8 parts

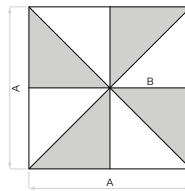

8 parts

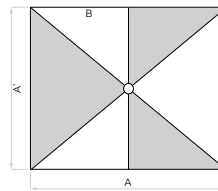

6 parts

Nominal size	Lateral distance	Pole Ø	Area covered	Height closed	Clear headroom	Total height	Clearance height, parasol part inclined	Total height, parasol part inclined	Foundation	Minimum weight for base	max. wind speed open perm.
cm	cm	cm	m ²	cm	cm	cm	cm	cm	cm	kg	km/h (wind force)
A	AS	M	B	E	F	G	K	L	C		
Ø 200	175	3.5	2.6	70...130	150...210	180...240	95...155	200...260	40×40	30	75 (9)
Ø 220	205	3.5	3.4	65...125	150...210	180...240	90...150	205...265	40×40	30	65 (8)
Ø 250	230	3.5	4.4	50...110	150...210	185...245	80...140	217...275	50×50	40	50 (7)
Ø 300	275	3.5	6.4	50...90	170...210	210...250	85...125	245...285	60×60	40	35 (5)
200×200	-	3.5	4.0	35...95	150...210	185...245	95...155	200...260	40×40	40	50 (7)
240×240	-	3.5	5.8	30...70	170...210	210...250	100...140	230...270	50×50	40	40 (6)
210×150	-	3.5	3.2	50...110	150...210	185...245	110...170	190...250	40×40	30	55 (7)
250×200	-	3.5	5.0	40...80	170...210	210...250	110...150	220...260	50×50	40	40 (6)

The listed measures represent extrapolated average values that may be slightly different on the product ($\pm 2\% \pm 5$ cm).

Height dimensions are based on ground socket BT. These vary slightly depending on the type of base. Except for steel base minus 5 cm.

The max. wind speed limits as per our separate sheet apply only if the parasol canopy is in a horizontal position and if there is a fix ground anchorage.

In the presence of several parasols, the minimum distance between one parasol and another and between parasols and walls shall be 20 cm.

Side mast parasols

Our cantilever parasols

In some places, the mast gets in the way. The parasol is located exactly where you want to benefit from shade or enjoy the view. With over 30 years of experience in the design of new parasol solutions, Albert Glatz registered the patent for the Pendalex back in 1959 – the world's first side-mast parasol.

GLATZ now offers six different cantilever models for private and professional applications.

... for the project business

The Ambiente Nova features a unique design and impresses with its subtle design language. A patented drive system ensures that operating the crank is absolute child's play. While the parasol roof automatically aligns itself horizontally when opened, its high closing height means that it does not touch the tables or seats below. In the evening, an optional warm-white LED lighting system, which is integrated in the ribs and mast, brings light into the darkness.

With a clear design and very stable structure, the Fortano complements the range of side-mast parasols and visually matches the F line. In addition to its closing height, it boasts fantastic stability, withstanding wind speeds of up to 55 km/h. The simple and synchronous opening and closing principle of the Ambiente Nova can also be found in the Fortano.



AMB **AMBIENTE Nova**
The queen of the side-mast parasols 54

- 300 to 500 cm + special sizes made to measure
- Max. 45 km/h wind stability
- Synchronised crank or motor opening system
- Opening mechanism with just a few crank turns and high closing height (patented)
- Optionally available with integrated LED lighting system
- Special product solutions (frame, fabrics, ...)



FA **FORTANO®**
The windproof side-mast parasol 58

- 300 to 400 cm
- Max. 55 km/h wind stability
- Synchronised crank opening system
- Opening mechanism with just a few crank turns and high closing height (patented)
- Anodised natural or anthracite frame ("RAL 7016") available
- Osyrion Spot battery-powered LED light with remote



1



2

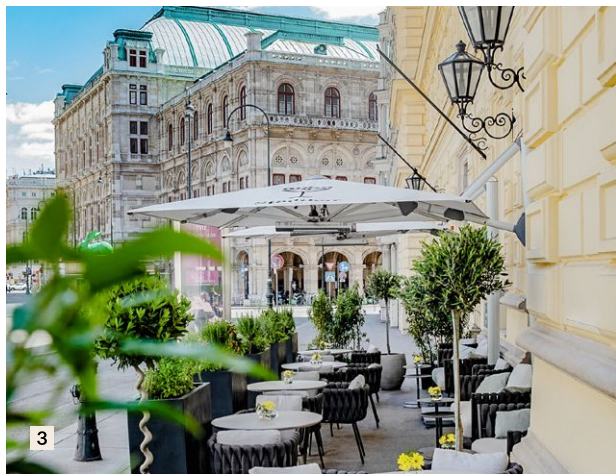

3



4



5

- 1 Kempinski Hotel Adlon – Berlin, DE
- 2 Bits Café & Bar – Wittenbach, CH
- 3 Stadtbar Vienna – Vienna, AT
- 4 Private Residence – Anonymus, PT
- 5 University of Education Thurgau – Kreuzlingen, CH

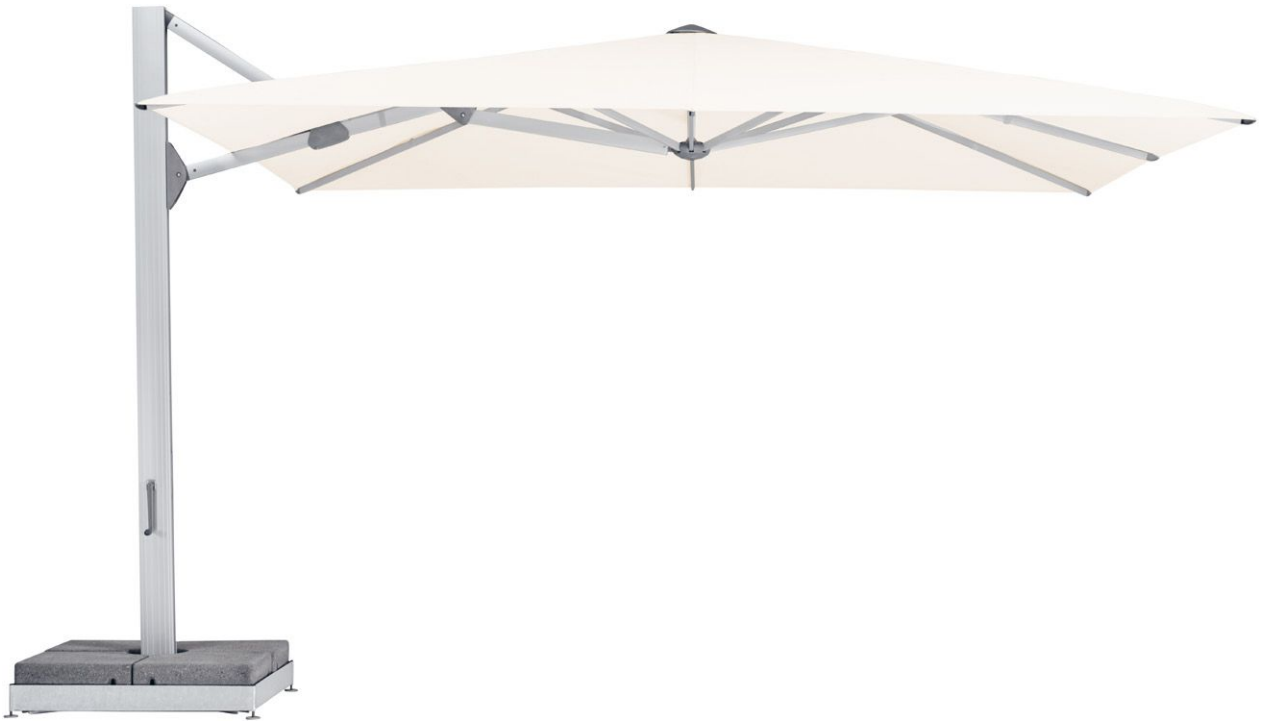

Unique selling proposition

- Unique design language: Harmonises with all giant parasols and F-line
- Continuous mast profile down to the floor covering (internal support tube)
- Patented and synchronous opening mechanism:
 - Operation via crank or motor
 - Simultaneous opening and extension of the parasol roof
 - Opened with just a few turns of the crank
 - High closing height (no need to move the furniture)
- 45 km/h wind stability at size 400 × 300 cm
- Top quality material selection
- Parasol can be rotated by 360° using the turnable adapter M4
- LED lighting system integrated into the struts and mast
- Special product solutions (Sizes, frame, fabrics, ...)

Places of use

- Large area outdoors
- Small area outdoors



Basic model

Frame

- 8 parts made from anodised aluminium
- Profiled straight mast
- Mast profile 85 × 145 mm and 4.5 mm wall thickness
- Roof struts 20 × 33 mm

Frame material

- Aluminium: EN-AW-6063-T66
- Screws and rivets made from stainless steel A4
- Glass-fibre reinforced plastic parts: PA6GF30
- Anodisation:
 - Profile surface finishing
 - High degree of hardness – wear resistance (“scratch-resistant”)
 - Increased corrosion resistance
 - Natural appearance (adaptation to environment)
 - Modern look (luxurious matt)

Frame colour

- Anodised natural matt
- RAL colours powder-coated (surcharge)
 - Powder coating on anodised profiles
 - (providing additional corrosion protection)

Opening principle (synchronous)

- Patented opening mechanism for high closing height
- Fast and simple operation thanks to synchronous opening and extension of the parasol roof
- Opened with just a few turns of the crank

Drive

- With hand crank (detachable)
- With motor (surcharge)

Canopy

- With or without flounce
- Self-tautening thanks to the flexible strut ends
- 100 % polyacrylic approx. 300 g/m² (spun dyed)
- Replaceable or interchangeable canopies

Wind stability

- Up to 45 km/h (with fixed anchorage)
- Tested in a wind tunnel

Fixations

74

- Bases / parasol stands / Covers
- Ground sockets
- Mounting plates without or with installation height made to measure
- Mounting plates for insulation floors
- Mounting plates for insulation floors with high insulation
- Base plates made to measure

Additional options – Standard accessories

88

- Turnable adapter M4 for 360° rotation (with electrical feed lines 310°)
- LED lighting system
- Motorisation
- Protective cover

Special product solutions – Made to measure

94

- Special sizes & intermediate measurements (increment 1)
- Mast extensions & reductions
 - max. + 400 mm / - 300 mm
- Frame in all RAL colours
- Glatz Green® Special fabric
- Special fabrics (third-party fabrics, flame retardant)
- Custom flounces & edging strips
- Printing & advertising print

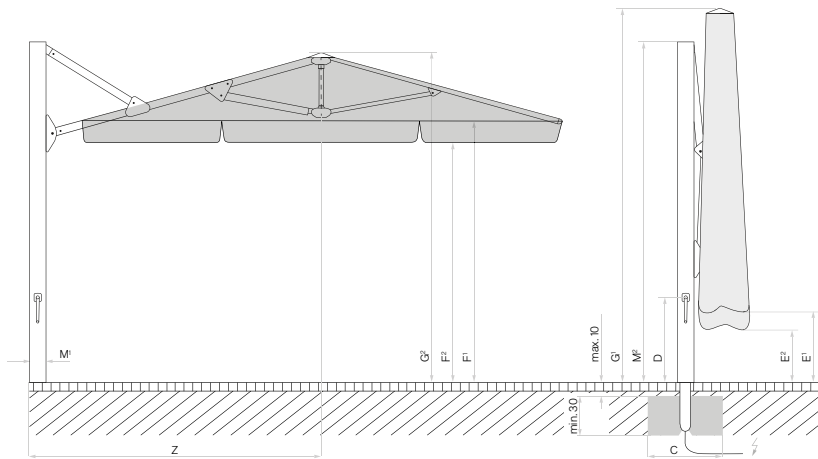

Loose cover max. 10 cm, concrete thickness min. 30 cm (pay attention to frost depth), Guarantee water drainage, Supply line electric.

LED positions on the Ambiente Nova with LED

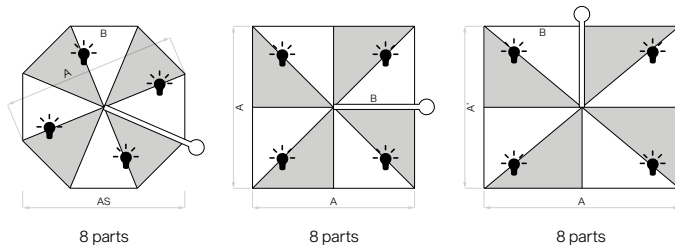

Nominal size	Lateral distance	Pole Ø	Area covered	Crank handle height	Height closed/with flounce	Lowest height when opening + closing/with flounce	Clear height when headroom/ with flounce open	Total height/ height/	Height of pole	Length of free-arm	Foundation	Minimum weight for base	max. wind speed open perm.
cm	cm	cm	m ²	cm	cm	cm	cm	cm	cm	cm	cm	kg	km/h (wind force)
A	AS	M ¹	B	D	E ¹ /E ²	F ¹ /F ²	G ¹ /G ²	M ²	Z	C			
Ø 400	370	8.5 × 14.5	11.3	91	158/134	148/124	225/201	365/295	295	232	80 × 80	240	45 (6)
Ø 500	460	8.5 × 14.5	17.7	91	146/122	136/112	225/201	401/305	295	281	100 × 100	310	35 (6)
350 × 350	-	8.5 × 14.5	12.3	91	92/68	82/58	225/201	343/285	295	213	80 × 80	240	40 (6)
400 × 400	-	8.5 × 14.5	16	91	80/56	70/46	225/201	367/290	295	232	100 × 100	310	35 (6)
400 × 300	-	8.5 × 14.5	12	91	80/56	70/46	225/201	334/270	295	184	80 × 80	240	45 (6)
450 × 350	-	8.5 × 14.5	15.8	91	80/56	70/46	225/201	368/285	295	232	100 × 100	310	35 (6)

The listed measures represent extrapolated average values that may be slightly different on the product (± 2% ± 5 cm).

If a minimum height underneath is required, this must be agreed with Glatz.

The measures of the height are determined by the M4 ground socket. If one of the offered bases is used, these measures change only slightly.

The max. wind speed limits as per our separate sheet apply only if the parasol canopy is in a horizontal position and if there is a fix ground anchorage.

In the presence of several parasols, the min. distance between one parasol and another and between parasols and walls shall be 25 cm.



1



2



3



4



5

- 1 Alpine resort Schwarz – Obermieming, AT
- 2 Victoria Jungfrau Grand Hotel & Spa – Interlaken, CH
- 3 Hotel & Tavern Grünauerhof – Wals, AT
- 4 GALAAXY Mountain Park – Laax, CH
- 5 Chalet 19 – Gaimersheim, DE

FA

FORTANO® The windproof side-mast parasol

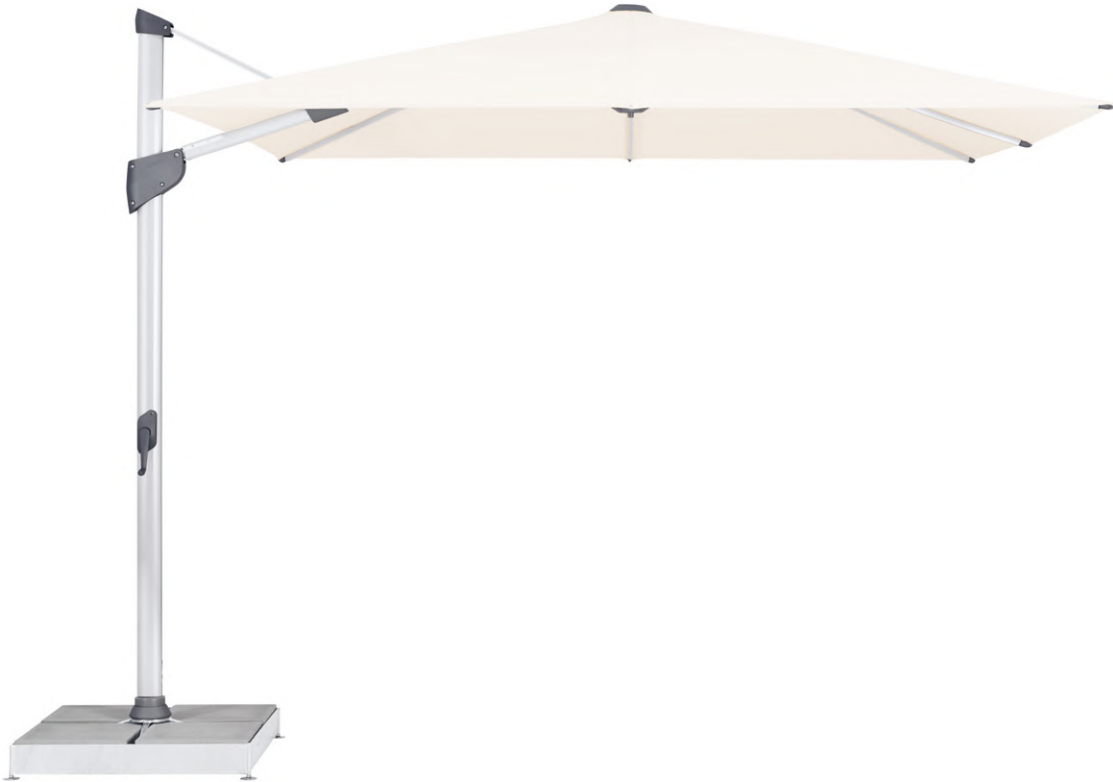

Unique selling proposition

- Unique design language: Harmonises with all giant parasols and F-line
- Continuous mast profile down to the floor covering (internal support tube)
- Patented and synchronous opening mechanism:
Operation via crank
Simultaneous opening and extension of the parasol roof
Opened with just a few turns of the crank
High closing height (no need to move the furniture)
- 55 km/h wind stability at size 300 × 300 cm
- Top quality material selection
- Parasol can be rotated by 360° using the turnable base M4
- Osyrion Spot battery-powered LED light with remote
- Anodised natural or anthracite frame ("RAL 7016")

Places of use

- Small area outdoors





Basic model

Frame

- 8 parts made from anodised natural aluminium
- Profiled straight mast
- Mast profile 66 × 95 mm and 3 mm wall thickness
- Roof struts 20 × 26 mm

Frame material

- Aluminium: EN-AW-6063-T5
- Screws and rivets made from stainless steel A2
- Anodisation:
 - Profile surface finishing
 - High degree of hardness – wear resistance (“scratch-resistant”)
 - Increased corrosion resistance
 - Natural appearance (adaptation to environment)
 - Modern look (luxurious matt)

Frame colour

- Anodised natural matt or anthracite (“RAL 7016”) powder-coated

Opening principle (synchronous)

- Patented opening mechanism for high closing height
- Fast and simple operation thanks to synchronous opening and extension of the parasol roof
- Opened with just a few turns of the crank

Drive

- With hand crank

Canopy

- Without flounce
- Self-tautening thanks to the flexible strut ends
- Available in 3 fabric qualities:
 - 100 % polyacrylic approx. 300 g/m² (spun dyed)
 - 100 % polyester approx. 250 g/m² (spun dyed)
 - 100 % polyester approx. 220 g/m² (piece dyed)
- Replaceable or interchangeable canopies

Wind stability

- Up to 55 km/h (with fixed anchorage)
- Tested in a wind tunnel

Fixations

74

- NEW Bases / parasol stands / covers
- Ground sockets
- Mounting plates without or with installation height made to measure
- Mounting plates for insulation floors
- Mounting plates for insulation floors with high insulation
- Base plates made to measure

Additional options – Standard accessories

88

- Turnable base M4 for 360° rotation
- Osyrion Spot battery-powered LED light, removable
- Protective cover

Special product solutions – Made to measure

94

- Glatz Green® Special fabric
- Special fabrics (third-party fabrics, flame retardant)
- Printing & advertising print

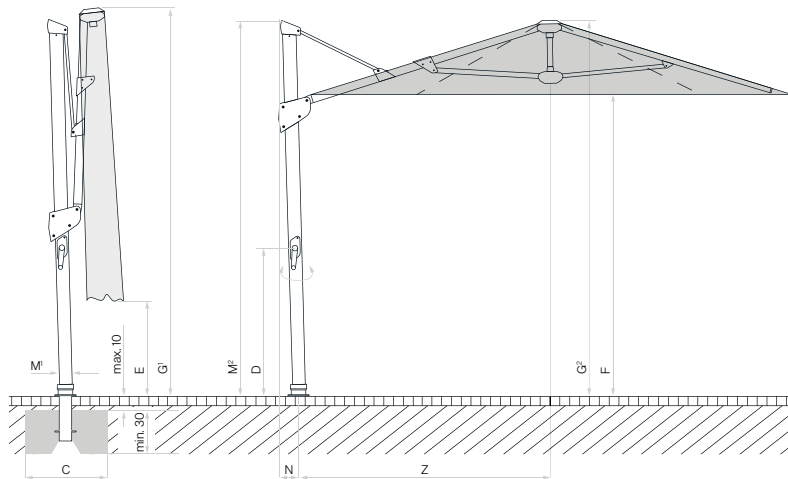

Loose cover max. 10 cm, concrete thickness min. 30 cm (pay attention to frost depth), Guarantee water drainage

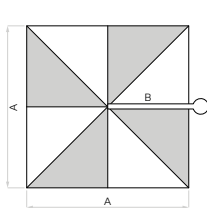

8 parts

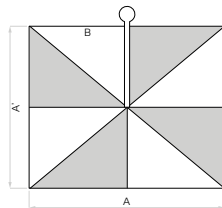

8 parts

Nominal size	Lateral distance	Pole Ø	Area covered	Crank handle height	Height closed	Clear headroom	Total height/open	Height of pole	Overhang at the back	Length of free-arm	Foundation	Minimum weight for base	max. wind speed open perm.
cm	cm	cm	m ²	cm	cm	cm	cm	cm	cm	cm	cm	kg	km/h (wind force)
A	AS	M'	B	D	E	F	G ² /G ²	M'	N	Z	C		
300×300	-	6.6×9.5	9	106	105	215	320/270	265	12	175	60×60	180	55 (7)
400×300	-	6.6×9.5	12	106	65	215	320/270	265	12	175	60×60	180	45 (6)

The listed measures represent extrapolated average values that may be slightly different on the product ($\pm 2\% \pm 5$ cm).

The height dimensions are based on the ground socket M4. With the base M4, 120 kg these vary by plus 11.5 cm and with the base M4, 180 kg by plus 15.5 cm.

The lowest height for opening/closing is 5 cm below the closing height.

The max. wind speed limits as per our separate sheet apply only if the parasol canopy is in a horizontal position and if there is a fix ground anchorage.

In the presence of several parasols, the minimum distance between one parasol and another and between parasols and walls shall be 20 cm.

Wooden parasols

Evoking emotions

Our wooden parasols evoke emotions not only in private gardens, but also in the best restaurants and hotels in the world. In fact, comfort and cosiness are the words that most people associate with wood.

Wood has a natural air about it. It's a warm material that people like to touch. We also make allowances for wood to age, change colour and develop a patina.

The design icon Alexo and the precious timber parasol Teakwood create a relaxed, natural environment. They are made at our factory in Frauenfeld from ash and teak through traditional craftsmanship.



TW **TEAKWOOD**
The elegant masterpiece in precious timber 64

- 300 to 350 cm
- Impresses with its charm and attention to detail
- Opening principle with double pulley system
- Sophisticated production and the finest choice of materials
- Frame made from untreated teak
- Leather edges, rustproof metal fittings and rope matching the pole colour
- Osyrion Spot battery-powered LED light with remote



AL **ALEXO®**
The classic parasol since 1931 68

- 200 to 220 cm
- THE classic + perfect for extraordinary concepts
- Easy to open by pressing the slide
- Elegant and typical brass gear joint for tilting
- Frame made from ash, struts made from fibreglass
- All versions can be customised
- Osyrion Spot battery-powered LED light with remote



1

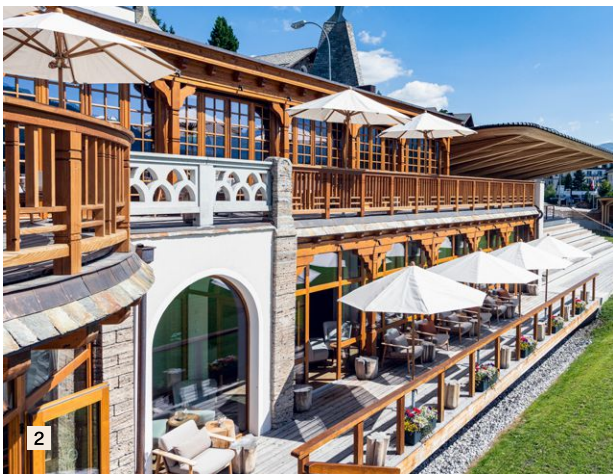

2



3



4

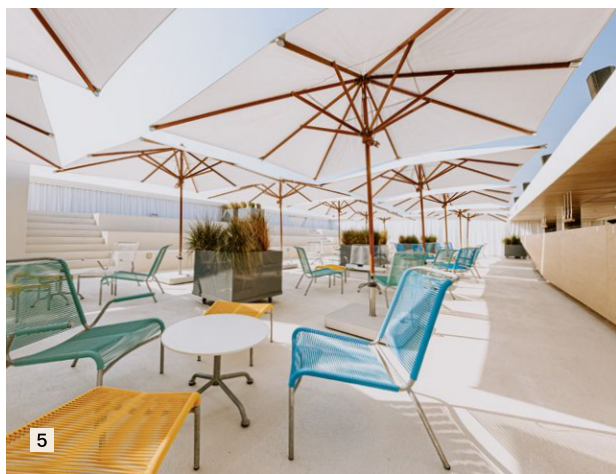

5

- 1 Osteria Alpina Bürgenstock – Obbürgen, CH
- 2 Kulm Hotel – St. Moritz, CH
- 3 Hotel Walther – Pontresina, CH
- 4 Private Residence – Anonymous, CH
- 5 Swiss Pavilion Expo – Dubai, AE

TW

TEAKWOOD

The elegant masterpiece in precious timber



Unique selling proposition

- Impresses with its charm and attention to detail
- With a focus on a classic ambience, nature and emotions
- Opening principle with double pulley system
- Sophisticated production and the finest material selection:
 - Frame made from untreated teak
 - Leather edges, rustproof metal fittings and rope matching the pole colour
 - Bottom section of the pole protected against moisture
- Osyrion Spot battery-powered LED light with remote

Places of use

- Small area outdoors

Basic model

Frame

- 8 parts made from teak
- Continuous pole
- Pole profile Ø 48 mm
- Roof struts 18 × 33 mm

Frame material

- Natural teak
- Rustproof metal fittings with stainless steel look and rope to match the pole colour
- Bottom section of the pole protected against moisture

Opening principle

- Double pulley system
- Parasol roof fastened with a metal pin (3 increments for retightening)

Canopy

- Without flounce
- With leather-reinforced fabric edges
- Available in 2 fabric qualities:
 - 100 % polyacrylic approx. 300 g/m² (spun dyed)
 - 100 % polyester approx. 250 g/m² (spun dyed)
- Replaceable or interchangeable canopies

Wind stability

- Up to 30 km/h (with fixed anchorage)

Fixations

74

- NEW Bases / parasol stands
- Ground sockets
- Mounting plates without or with installation height made to measure

Additional options – Standard accessories 88

- Osyrion Spot battery-powered LED light, removable
- Protective cover

Special product solutions – Made to measure 94

- Glatz Green® Special fabric
- Special fabrics (third-party fabrics, flame retardant)
- Printing & advertising print

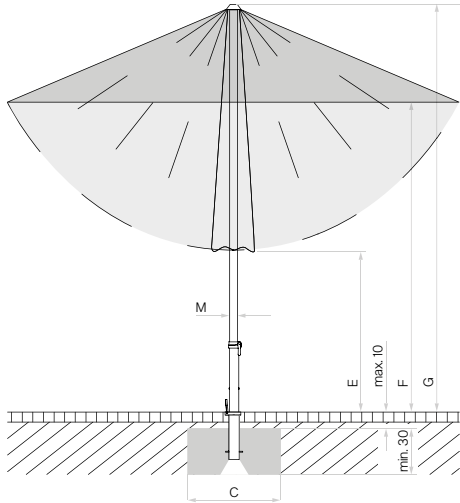

Loose cover max. 10 cm, concrete thickness
min. 30 cm (pay attention to frost depth), Guarantee
water drainage

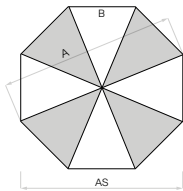

8 parts

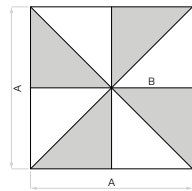

8 parts

Nominal size	Lateral distance	Pole Ø	Area covered	Height closed	Clear headroom	Total height	Foundation	Minimum weight for base	max. wind speed open perm.
cm	cm	cm	m ²	cm	cm	cm	cm	kg	km/h (wind force)
A	AS	M	B	E	F	G	C		
Ø 300	275	4.8	6.4	135	220	285	60×60	40	30 (5)
Ø 350	325	4.8	8.7	105	215	285	60×60	55	30 (5)
330×330	-	4.8	10.9	45	220	285	60×60	70	30 (5)

The listed measures represent extrapolated average values that may be slightly different on the product ($\pm 2\% \pm 5$ cm).

The height dimensions are based on the ground socket PX. In the base variations these might differ slightly. Apart from the steel base minus 7.5 cm.

The max. wind speed limits as per our separate list apply only in the presence of a fix ground anchorage.

In the presence of several parasols, the minimum distance between one parasol and another and between parasols and walls shall be 20 cm.



1



2



3



4

- 1 Kindli 1474 – Zurich, CH
- 2 Hotel Guarda Val – Lenzerheide, CH
- 3 SILO by Talent – Basel, CH
- 4 Arlberg Hotel – Lech, AT

AL

ALEXO®

The classic parasol since 1931



Unique selling proposition

- THE classic + perfect for unusual concepts
- Impresses with its unique effect and its aura
- Easy to open by pressing the slide
- Elegant and typical brass gear joint for tilting
- The best production and finest material selection:
Frame made from ash, struts made from fibreglass
- All versions can be customised
- Osyrion Spot battery-powered LED light with remote

Places of use

- Small area outdoors



Basic model

Frame

- 10 parts made from ash
- Pole profile Ø 30 mm

Frame material

- Ash with a clear varnish
- Struts made from fibreglass (white)
- Mast including gear joint made from nickel-plated brass

Opening principle & functions

- Push-up function (press the slide)
- Parasol roof can be tilted using the tilt joint

Canopy

- With or without flounce
- With leather-reinforced fabric edges
- Available in 2 fabric qualities:
 - 100 % polyacrylic approx. 300 g/m² (spun dyed)
 - 100 % polyester approx. 250 g/m² (spun dyed)
- Replaceable or interchangeable canopies

Wind stability

- Up to 20 km/h (with fixed anchorage)

Fixations

74

- NEW Bases / parasol stands
- Ground sockets

Additional options – Standard accessories

88

- Osyrion Spot battery-powered LED light, removable
- Protective cover

Special product solutions – Made to measure

94

- Glatz Green® Special fabric
- Special fabrics (third-party fabrics, flame retardant)
- Custom flounces & edging strips
- Printing & advertising print

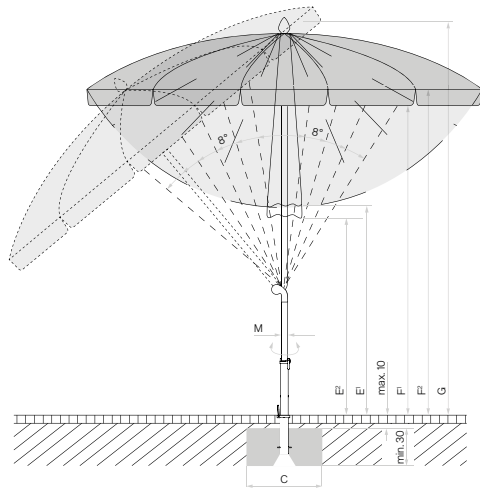

Loose cover max. 10 cm, concrete thickness
min. 30 cm (pay attention to frost depth), Guarantee
water drainage

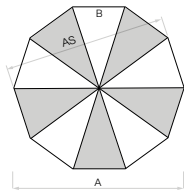

10 parts

Nominal size	Lateral distance	Pole Ø	Area covered	Height closed/ with flounce	Clear headroom/ with flounce	Total height	Foundation	Minimum weight for base	max. wind speed open perm.
cm	cm	cm	m ²	cm	cm	cm	cm	kg	km/h (wind force)
A	AS	M	B	E¹/E²	F¹/F²	G	C		
Ø 200	190	3.0	2.9	135/ 125	215/ 200	245	40 × 40	30	20 (4)
Ø 220	210	3.0	3,6	125/ 115	210/ 195	245	40 × 40	30	20 (4)

The listed measures represent extrapolated average values that may be slightly different on the product ($\pm 2\% \pm 5$ cm).

The measures of the height are determined by the ST ground socket. If one of the offered bases is used, these measures change only slightly. Apart from the steel base minus 5 cm.

The max. wind speed limits as per our separate sheet apply only if the parasol canopy is in a horizontal position and if there is a fix ground anchorage.

In the presence of several parasols, the minimum distance between one parasol and another and between parasols and walls shall be 20 cm.

Fabric collection

Made in Switzerland – Made by Glatz

Glatz's 125 years of experience are also reflected in the perfectly fitting canopies. The outstandingly high-quality fabrics and precision work are combined in the in-house sewing workshop. Thanks to the manufacturing approach, virtually anything is possible when it comes to individuality and creativity. Whether you want parasols with differently coloured edging strips, special frills or segments in alternating colours – Glatz manufactures every canopy to meet your specific wishes.

Glatz fabric qualities

All Glatz fabrics are divided into the fabric qualities 2, 4 and 5 based on their material, coating and UV protection. The high quality and resistance of a fabric can be measured based on its light fastness, fabric weight, hydrostatic head and the UV protection. Each of the three fabric qualities guarantees a maximum possible UV protection of more than 98 percent.

Light fastness

If a parasol is frequently exposed to sunlight, the fabric fades over time. The light fastness of a fabric determines how much and how quickly the colour intensity fades. The following applies here: The higher the fabric quality, the better the light fastness, and as a result, the longer the period before it starts to fade. The light fastness of Glatz canopies is determined according to the standard ISO 105 B02.

Morning Light

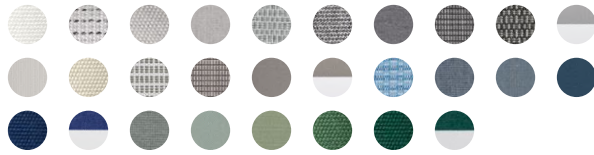

Sunset Glow



Morning Light

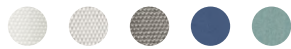

Sunset Glow



Morning Light



Sunset Glow



Fabric Quality 5

The premium collection



- 100 % polyacrylic
- Spun dyed
- Approx. 300 g/m² weight per square metre
- Class 7-8 light fastness (350-700 days) (ISO 105 B02)
- Water pressure resistance >350 mm
- UV protection: UPF 50+ and 98-100 % UV PROTECTION
- Scotchgard® and Teflon® coating
- Dirt repellent and resistant to mould

Fabric Quality 4

The intermediate stage



- 100 % polyester
- Spun dyed
- Approx. 250 g/m² weight per square metre
- Class 7 light fastness (350 days) (ISO 105 B02)
- Water pressure resistance >150 mm
- UV protection: UPF 50+ and 98-100 % UV PROTECTION
- Dirt repellent and resistant to mould

Fabric Quality 2

Budget-driven



▪ **Not recommended for the project business**

- 100 % polyester
- Piece dyed
- Approx. 220 g/m² weight per square metre
- Class 5 light fastness (80 days) (ISO 105 B02)
- Water pressure resistance >100 mm
- UV protection: UPF 50+ and 98-100 % UV PROTECTION

Special fabrics



- For details, see special products (page 94)

Fixations

The right solution for every situation

Stability and steadiness are the central foundation of a Glatz parasol. A wide variety of fastening options are available depending on the ground conditions and the local situation. They can be customised if desired.

Please note that the maximum permissible wind speeds for all models require fixed anchoring in the ground. Mobile parasols are possible depending on the place of use. In this case, a Glatz base or parasol stand is required for secure fixation. The recommended minimum base weight for the respective parasol must be adhered to.

The topic of fixations is a science in itself. Our Glatz Contract professionals are very familiar with this topic. We'll find the ideal shading solution for you with a long-term secure ground fixation, so that your guests feel safe in any weather.

Tailored special solutions: +41 52 723 66 44

Fixed anchorage



Ground

76

- Ground socket + connection tube
- Ground socket + support tube
- NEW Ground socket + tip-over hinge

Hard coverings without insulation

78

- Mounting plate without installation height
- Mounting plate with installation height made to measure



Hard coverings with insulation

80

- Mounting plate for insulation floors
- Mounting plate for insulation floors with high insulation

Special situations

82

- Base plate with installation height
- Wall clamp with projection
- Special adapter / adapter of any kind

Bases / parasol stands



Fixed – Without castors

84

- Steel base + support tube (40 and 70 kg)
- Concrete base + support tube (30 to 90 kg)
- Granite base + support tube (40 to 90 kg)
- Base frame + support tube (120 and 180 kg) + Covers
- Base frame + tip-over hinge (240 to 690 kg) + Covers



Mobile – Base with castors

86

- Granite base + support tube (40 and 55 kg)
- NEW Design base with castors + support tube (55 and 90 kg)
- Granite base + support tube (120 kg)
- NEW Design base with castors + support tube (120 and 180 kg)
- Base frame including set of castors + support tube (120 and 180 kg) + Covers

Fixed anchorage Ground

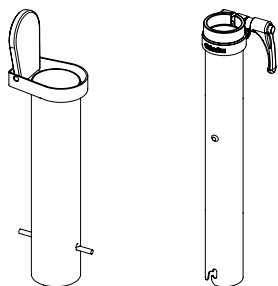

Ground socket + connection tube

FL FR FI AS TW AL

- Smart fixation for quickly removing the parasol
- For locations which have to be cleared every day (e.g. pavement)
- Connection tube is inserted into the ground socket
Fortello with special adapter + Support tube M4
- Galvanised steel or stainless steel V2A ground socket
- Galvanised steel or stainless steel V2A connection tube

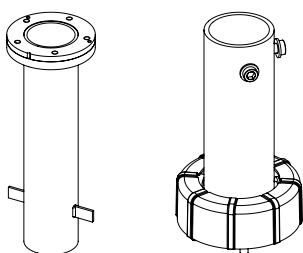

Ground socket + support tube

PZN PZS CAS FL FR FI AMB FA TW

- Very stable fixation for parasols up to 500 cm
- Tip-over hinge recommended for parasols of 500 cm or larger
- Support tube is screwed into the ground socket
- Galvanised steel ground socket (stainless steel on request)
- Support tube M4 galvanised steel essential

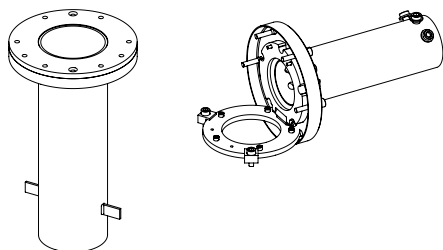

NEW Ground socket + tip-over hinge

PZR PZN PZS

- Very stable fixation for parasols of 500 cm or larger
- Tip-over hinge recommended for parasols of 500 cm or larger because these can be stored
- Tip-over hinge is screwed into the ground socket
- Galvanised steel ground socket (stainless steel on request)
- Galvanised steel tip-over hinge M8 / M16 essential

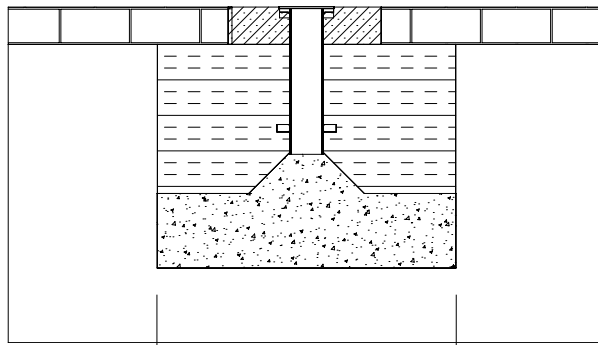

- _____ Slabs or other <10 cm
- _____ Concrete foundation min. 30 cm
- _____ Compressed filter gravel
- _____ Observe frost line

Width varies depending on the parasol size

Foundation dimensions

Parasol	Width	×	Length	×	Height
	cm		cm		cm
Up to 10 m ²	70		70		40*
Up to 15 m ²	80		80		40*
Up to 20 m ²	100		100		40*
Up to 25 m ²	120		120		40*
Up to 30 m ²	125		125		40*
Up to 40 m ²	135		135		40*
Up to 50 m ²	150		150		40*

* from 1,000 m above sea level, 50 cm is recommended because of the frost line

Fixed anchorage

Hard coverings without insulation

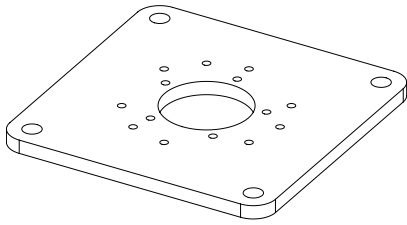

Mounting plate without installation height



- Especially suited to areas without a cellar underneath
- Anchorage via anchor screws in the rough surface
- Thickness and characteristics of the rough surface must be checked
- Customer provides the fixation material (depends on surface)
- Galvanised steel mounting plate (stainless steel on request)
- Support tube M4 or tip-over hinge M8 / M16 mountable

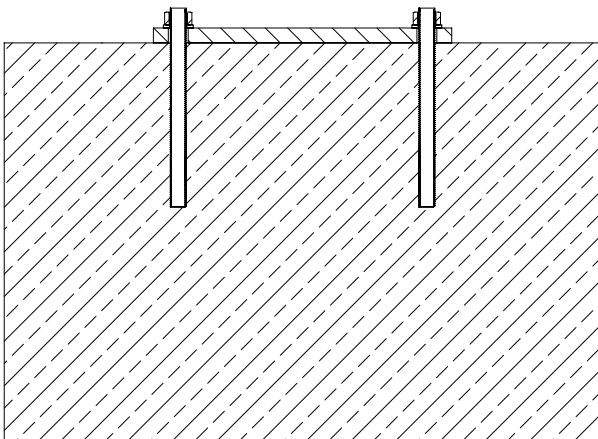

Rough surface
(Thickness and characteristics important!)

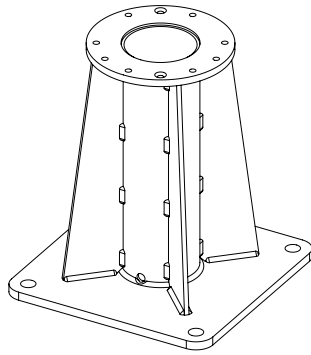

Mounting plate with installation height

PZR PZN PZS CAS FL FR FI AMB FA TW

- Suitable for areas with terrace structures
- The height of the mounting plate is produced to measure (top of rough surface to top of terrace structure = **Height H**)
- Anchorage via anchor screws in the rough surface (Waterproofing essential for areas with cellars underneath)
- Thickness and characteristics of the rough surface must be checked
- Customer provides the fixation material (depends on surface)
- Galvanised steel mounting plate (stainless steel on request)
- Support tube M4 or tip-over hinge M8 / M16 mountable

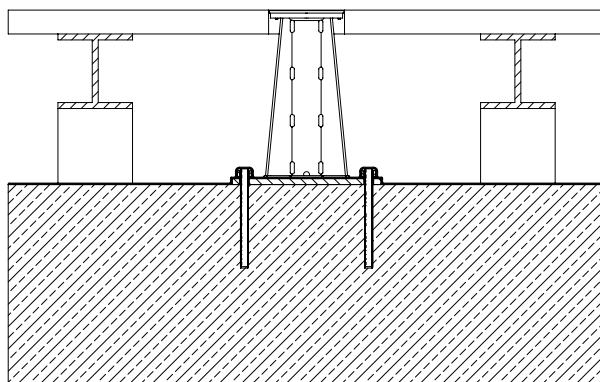

— Top of terrace structure

— Terrace structure (**Height H**)

— Waterproofing

— Rough surface
(Thickness and characteristics important!)

—

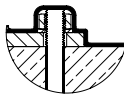

— Waterproofing

Fixed anchorage

Hard coverings with insulation

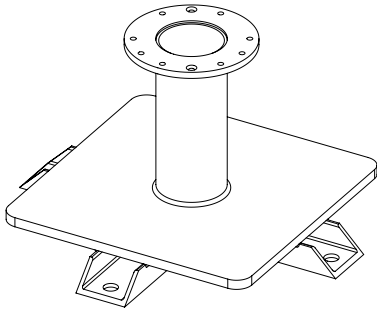

Mounting plate for insulation floors



- Suitable for areas with terrace structures
- The height of the mounting plate is produced to measure (top of insulation to top of terrace structure = **Height H**) (Waterproofing essential above insulation and plate)
- Anchorage with threaded bolts in rough surface (top of rough concrete to top of insulation < **140 mm**)
- Customer provides the fixation material (depends on surface)
- Minimises thermal bridge
- Stainless steel V2A mounting plate
- Support tube M4 or tip-over hinge M8 / M16 mountable

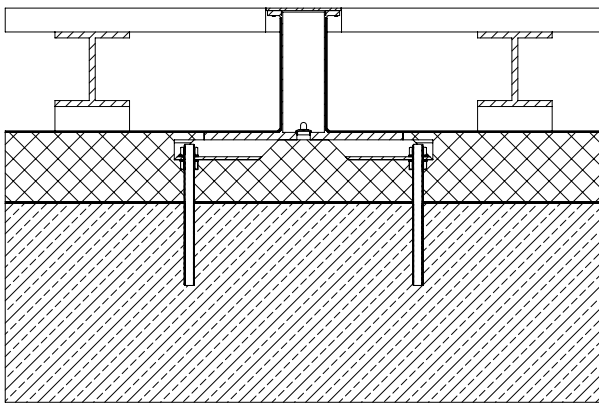

- Top of terrace structure
- Terrace structure (**Height H**)
- Waterproofing
- Insulation < **140 mm**
- Waterproofing (optional)
- Rough surface
(Thickness and characteristics important!)

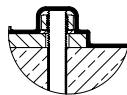

- Waterproofing

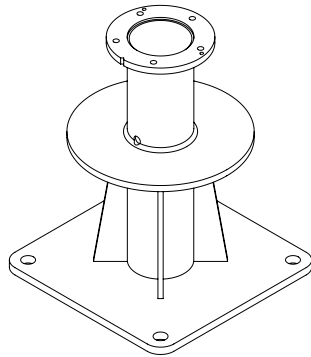

Mounting plate for high insulation



- Suitable for areas with terrace structures
- The height of the mounting plate is produced to measure (top of insulation to top of terrace structure = **Height H**) (Waterproofing essential above insulation and ring)
- Anchorage with anchor screws in rough surface (top of rough concrete to top of insulation > **140 mm = Height J**)
- Customer provides the fixation material (depends on surface)
- Galvanised steel mounting plate (stainless steel on request)
- Support tube M4 or tip-over hinge M8 / M16 mountable

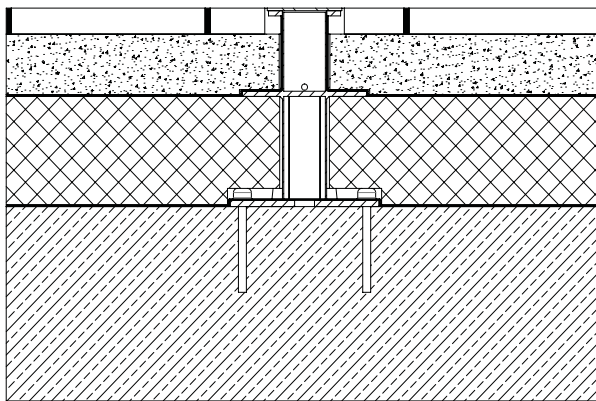

- Top of terrace structure
- Terrace structure (**Height H**)
- Waterproofing
- Insulation > **140 mm (Height J)**
- Waterproofing (optional)
- Rough surface (Thickness and characteristics important!)

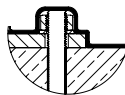

- Waterproofing

Special situation

No mechanical anchorage possible

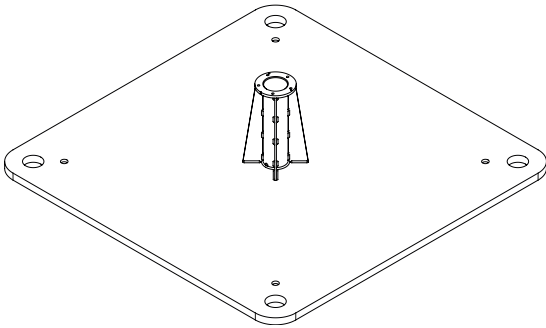

Base plate with installation height



- Suitable for areas with terrace structures
- The height of the base plate is produced to measure (top of rough surface to top of terrace structure = **Height H**)
- Anchorage is replaced and guaranteed by the weight and the size of the base plate (no damage to the rough surface required)
- The area and weight are calculated based on the parasol
- Base plate is placed between the top of the rough surface and the terrace structure (it is important to level off the plate!)
- Transport aids in the corners (thread and hole)
- Galvanised steel base plate
- Support tube M4 or tip-over hinge M8 / M16 mountable

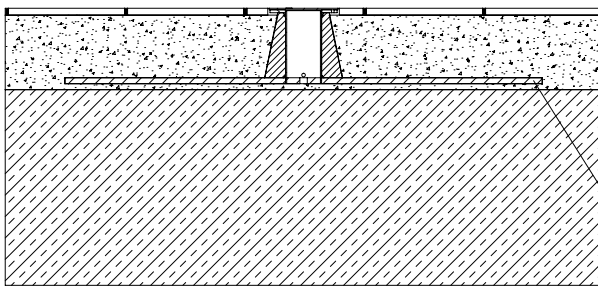

- Top of terrace structure
- Terrace structure (**Height H**)
- Waterproofing
- Rough surface (load-bearing capacity important!)
- Base plate placed to measure (e.g.: 150 × 150 × 2 cm = 355 kg)

Special situation

Anchorage to a wall

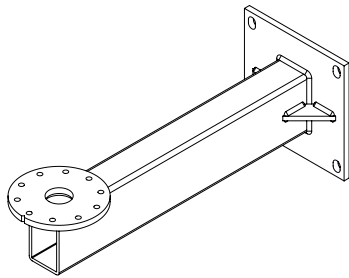

Wall clamp with projection

FL FR FI AS AMB FA TW AL

- Suitable for walls and masonry
- Clamp projection 100, (180) or 480 mm (projections to measure on request)
- Anchorage with heavy-duty anchorage bolts in the concrete wall
- Customer provides the fixation material (depends on wall)
- Galvanised steel wall clamp (stainless steel on request)
- Support tube Z or M4 mountable

Special situation

Special adapter

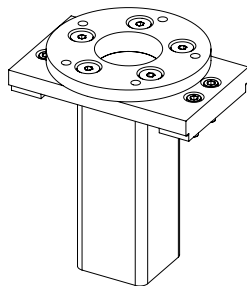

Adapter of any kind

PZR PZN PZS CAS FL FR FI AS AMB FA TW AL

- For Glatz fixations which have become detached due to age
- For fixations for other parasol brands

Bases / parasol stands

Fixed – Without castors



Steel base Z

FR FI AS TW AL

- 40 or 70 kg (40 + 30 kg add-on weight)
- Dimensions 58.5 × 58.5 × 2 cm
- Galvanised steel plate
- Support tube Z essential
- Galvanised steel or stainless steel V2A support tube Z



Concrete base Z

FR FI AS TW AL

- 30, 40, 55, 70 or 90 kg
- Dimensions from Ø 47 bis 75 cm
- Support tube Z essential
- Galvanised steel or stainless steel V2A support tube Z



Granite base Z

FR

- 90 kg
- Dimensions 64 × 64 × 9 cm
- Support tube Z essential
- Galvanised steel or stainless steel V2A support tube Z



Base frame M4



- 120 or 180 kg (option: with castors)
- Dimensions 96 × 96 × 11.5 to 19.5 cm
- Galvanised steel base frame
- Concrete or polished granite plate set
- Support tube M4 essential

- Cover for base M4 120 or 180 kg
- Plastic ABS coated
- Standard colours: Anodized aluminium look or anthracite

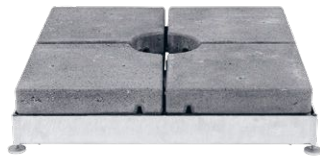

Base frame M4 / M8 / M16



- 240, 310, 430, 570 or 690 kg
- Dimensions 105 × 105 × 12 to 38 cm
- Galvanised steel base frame
- Concrete element set (special shape)
- Support tube M4 or tip-over hinge M8 / M16 essential

- Cover for base M4 / M8 / M16 240 or 310 kg
- Aluminium powder-coated
- Standard colours: Aluminium light grey or anthracite
- Special colours: Colours in RAL (surcharge)

Bases / parasol stands

Mobile – With castors



Granite base Z



- 40 or 55 kg
- Dimensions from 45 × 45 × 8 cm / 55 × 55 × 9 cm
- With replaceable castors and extendable handle
- Support tube Z essential
- Galvanised steel or stainless steel V2A support tube Z



NEW Design base with castors Z



- 55 or 90 kg
- Dimensions from 65 × 65 × 11 cm / 80 × 80 × 11.5 cm
- Design base made of concrete with selectable decor plate
- Support tube Z essential
- Galvanised steel or stainless steel V2A support tube Z



- Decorative plate for base 55 or 90 kg
- Plastic double printed
- Standard colours: grey, anthracite or sand



Granite base M4



- 120 kg
- Dimensions 90 × 90 × 17 cm
- With replaceable castors (all lockable)
- Support tube M4 essential
- Galvanised steel support tube M4



NEW Design base with castors M4



- 120 or 180 kg
- Dimensions: 80 × 80 × 15 cm / 94 × 94 × 15 cm
- Design base (base frame white or anthracite powder coated)
- Weight set made of concrete
- Support tube M4 essential



- Decorative plate for base 120 or 180 kg
- Plastic
- Standard colours: grey, anthracite or sand



Base frame M4 including set of castors



- 120 or 180 kg
- Dimensions 96 × 96 × 11.5 to 19.5 cm
- Galvanised steel base frame
- Concrete or polished granite plate set
- Support tube M4 essential



- Cover for base M4 120 or 180 kg
- Plastic ABS coated
- Standard colours: Anodized aluminium look or anthracite

Additional options

Standard accessories for all your needs

Motor drives, lighting variants, heaters, rain gutters, side walls, protective covers. The standard accessories and additional options from Glatz are extremely diverse and can be individually tailored to your needs. We can also cater to special requests and project-specific requirements with custom products (from page 94).

There is a huge demand for parasols, especially in the contract sector. With our all-round care-free package, we guarantee that everything will fit perfectly in the end. Experience has taught us that the more that can be integrated under a parasol roof, in the mast or the ribs, the better. Lighting in different colours, heaters and automated processes are prime examples of this. It goes without saying that the aesthetics also meet the highest standards.

There are also plenty of protection options for the materials. We have the accessories that will turn your Glatz parasols into long-lasting friends.

Electronic equipment

90



- LED lighting system Palazzo line
- LED lighting system Castello Pro
- LED lighting Fortello with battery pack
- Osyrion Spot battery-powered LED light with remote
- LED lighting system Ambiente Nova
- Infrared radiant heater
- Motorisation
- BUS system / connection to the home control system

Textiles

92



- Rain gutters Triangular
- NEW Self-supporting rain gutters
- Side walls

Material protection

93



- Protective covers
- Protective covers with corset lacing
- Strap systems

Additional options

Electronic equipment



LED lighting system PALAZZO® line

PZR PZN PZS

- RGBW (colour and white)
- 8 LED stripes integrated into the struts (4 direct + 4 indirect)
- LED stripes integrated along the entire length of the strut
- Direct and indirect stripes can be controlled individually
- Power supply via parasol mast (230V / 10A)
- Controlled remotely (functions labelled)



LED lighting system CASTELLO® Pro

CAS

- RGBW (colour and white)
- 8 LED stripes integrated into the struts (4 direct + 4 indirect)
- LED stripes integrated along the entire length of the strut
- Direct and indirect stripes can be controlled individually
- Power supply via parasol mast (230V / 10A)
- Controlled remotely (functions labelled)



LED lighting FORTELLO® with battery pack

FL

- White (approx. 2700K, 3200lm), continuously dimmable
- 4 LED stripes integrated into the struts
- No power supply required (Energy via battery pack)
- Lithium-ion battery pack with 150Wh and protective class IP54
- Light duration 10h at the recommended level (4h on max. level)
- Not suitable for corrosive environments



Osyrion Spot battery-powered LED light with remote

PZN PZS CAS FL FR FI AS AMB FA TW AL

- White (approx. 2700K, 320lm each spot), 5 levels dimmable
- Easily attach the light sources using the magnetic plates
- Control via intuitive Glatz remote
- Integrated battery with protective class IP54
- Light duration 4h at 50% light level
- Spots available in sets of 2 or 4 (connect up to 8 spots)

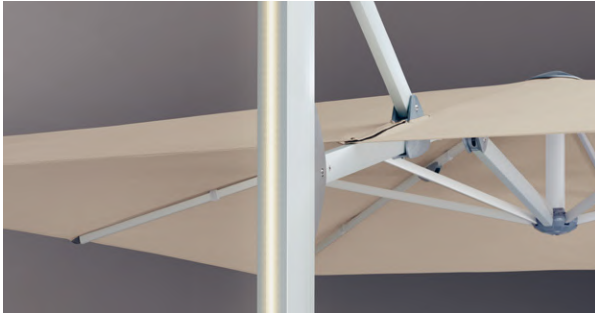

LED lighting system AMBIENTE Nova

AMB

- White (approx. 2700K, min. 4000lm)
- 8 LED stripes integrated into the struts (4 direct + 4 indirect)
- 1 LED stripe integrated along the mast
- Every stripe can be controlled individually
- Power supply via parasol mast (230V / 10A)
- Controlled remotely (functions labeled)



Infrared radiant heater

PZR PZN PZS CAS

- New Glatz design heater
- Polished aluminium infrared heater (1500W, 230V, 6.5A)
- Max. 4 heaters can be mounted on each parasol
- Power supply via parasol mast (400V / 16A)
- Controlled remotely or via BUS system



Motorisation

PZR PZN PZS AMB

- Venetian blind drive including soft-start function
- Motor inside the parasol mast (not visible)
- Power supply via parasol mast (230V / 10A)
- Controlled remotely or via BUS system
- Closing of motorised parasols not possible at wind speeds > 35 km/h



BUS system / connection to the home control system

PZR PZN PZS

- The use of this control system requires BUS competence (normally KNX) on the part of the customer
- No remote control units are necessary for any of the BUS control systems
- Various other functions can be combined by the customer once programmed: Timer, wind monitor, ...

Additional options

Textiles



Rain gutters Triangular

PZR PZN PZS CAS

- Triangular construction as standard:
 - Conical structure for easy runoff
 - No sagging due to "triple-tube" design (see picture)
 - Modern look
- Customer is free to choose the material colour of the rain gutter
- Interior doubling made from waterproof PVC
- Length of the rain gutter produced to measure
- The side connection tubes do not sag
- Connection tube fitted with plug connections and detachable conical spring
- Fixation to the struts via levelling clasps and clamps
- Various modular parts of the neighbouring parasol?
 - Fixation points are adjusted (e.g.: 3/4, 4/3, ...)
- Special rain gutters on request (Length, width, height, ...)

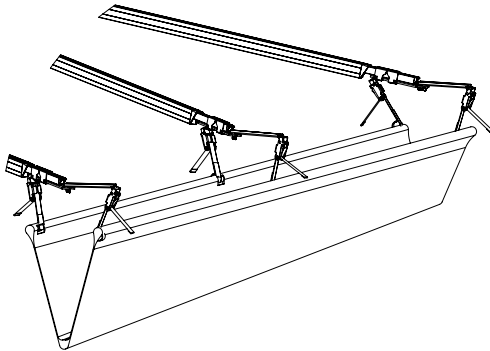

NEW Self-supporting rain gutters

PZR PZN PZS

- Solution to protect passageways
 - e.g. between the parasol and facade
- Triangular rain gutter is mounted on a single parasol
- No opposing fixation necessary
- Mounted to the rib using a levelling buckle and suspension profile

Side walls

PZR PZN PZS CAS



- Customer is free to choose the fabric colour
- Length = Side length of the parasol
- Height = Height underneath the parasol (without flounce) minus 10 cm
- PVC window can be sewn in (optional)
- PVC runoff lip at the end of the side wall (optional)
- Edge connections, zip fastener or Velcro (optional)
- No flapping owing to support tubes below
- No sagging due to the connection tubes
- Connection tube fitted with plug connections and detachable conical spring
- Fixation to the struts via levelling clasps and clamps
- Sewn-on D rings for connection to the ground

Additional options

Material protection



Protective covers



- Rod and zipper to help you pull on the cover easily
- Woven with special rip-stop technology
- Highly tear-resistant through the integration of thick threads
- Polyurethane coating on the inside of the cover protects against moisture from the outside



Protective covers with corset lacing



- Rod and zipper to help you pull on the cover easily
- Corset lacing to keep the parasol compact
- Woven with special rip-stop technology
- Highly tear-resistant through the integration of thick threads
- Polyurethane coating on the inside of the cover protects against moisture from the outside



Strap systems



- Tying lace included in the delivery of a new parasol
- Tie system also helps to tie large rectangular sizes up properly and in a compact form
- No flapping in strong winds thanks to compact tying

Special product solutions

Our factory even makes the seemingly impossible possible

The Glatz development and project department embodies innovative strength and ingenuity every day. In our modern factory, we draw on the decades of experience and the specialist knowledge of our employees to find a tailored solution for every situation, no matter how challenging.

We always take the following points into account:

- Use of high-quality materials
- Application of the latest production methods
- High-quality craftsmanship by loyal and experienced employees
- A constant goal of improvement and innovation

Driven by over 125 years of ingenuity and the passion for the perfect shade solutions, we do the seemingly impossible for your project..

We look forward to your challenge: +41 52 723 66 44



- Special sizes level 1
- Special sizes level 2
- Special sizes level 3 (Shapes and decentralised mast)
- Pole extensions & reductions
- Frame in all RAL colours

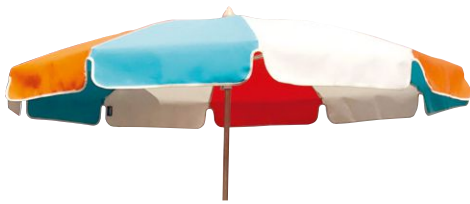

- Glatz Green® (The parasol that purifies the air)
- Third-party fabric (fabric not from the Glatz collection)
- PVC materials
- Flame-retardant fabric
- Custom flounces & edging strips
- Printing & advertising print

Special product solutions

Frames

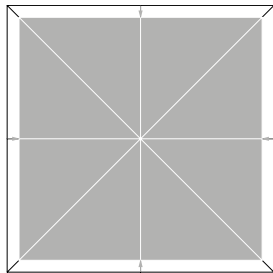

Original size / Special size

Special sizes level 1

PZR PZN PZS CAS AMB

- Proportional reduction of the original size (original size = the next larger standard size)
- Special size level 1 in 5 cm increments possible
- Maximum reduction to limit measurement

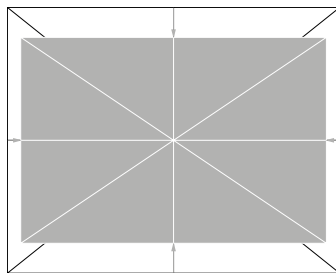

Original size / Special size

Special sizes level 2

PZR PZN PZS

- Non-proportional reduction of the original size (original size is defined by the development team)
- Special size level 2 is redrawn
- Technical production limit at a 2:1 ratio

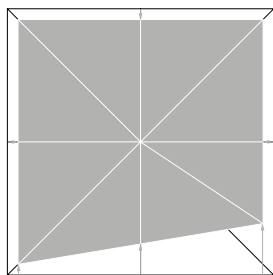

Original size / Special size

Special sizes level 3

PZR PZN

- Asymmetrical shape of the original size (original size is defined by the development team)
- Decentralised placement of the mast possible
- Special size level 3 is redesigned

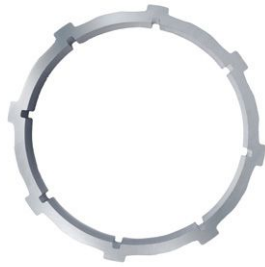

Mast extensions & reductions



- Maximum extension / reduction depends on the model
- It makes sense to adapt the parasol height, height underneath or closing height to suit the local situation
- The wind stability is reduced when the mast is extended



Frame colour in RAL



- Powder coating in all RAL colours (NCS colours)
- Powder coating of anodised profiles (creating additional corrosion protection)
- Powder coating of all metal frame parts:
Corrosion class C3 / HWF59 / Qualicoat class 2
Corrosion protection C5 (possible on demand)
- Liquid-painting of all visible plastic parts

Special product solutions

Parasol canopies

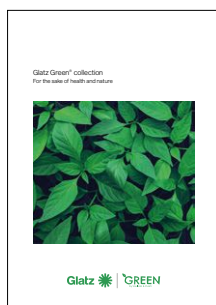

Glatz Green® Collection



- The parasol that purifies the air
- 100% polyacrylic
- Specifications same as fabric quality 5
- Coating: Green TiO₂ nanoparticles
- How it works: photocatalysis
- 3 brands – 1 mission: Glatz, Sauleda, Pureti



Third-party fabrics



- Fabrics outside the Glatz collection
- Quality must correspond to fabric quality 5
- 100 % polyacrylic
- Approx. 300g/m² weight per square metre
- Suppliers: Dickson, Para, Sattler
(more suppliers on request)



PVC materials



- Particular area stability and high robustness
- Used in particularly exposed locations
- 100 % polyester 550 Dtex with PVC coating
- Approx. 480g/m² weight per square metre
- Products: TEXOUT® Precontraint 302
(more products on request)



Flame-retardant fabric



- Special fabric with low flammability
- Used wherever it is required
- Observe country-specific fire safety standards
(Examples: B1 DIN 4102-1 / B-s2 d0 EN 13501-1)
- Products: Dickson SPARK FR, Sattler FIREMASTER
(more products on request)



Custom flounces & edging strips



- Split or continuous flounces
- Various flounce heights
- Flounce colour selection
- Edging strips colour selection
- Different coloured segments



Printing & advertising print



- Screen printing on fabric qualities 4 and 5
- Full surface screen printing on polyester (minimum quantities)
- Printable logo in EPS format required
- **References:** McDonald's, Burger King, Nestlé, ...

Checklist

Have you thought of everything?

Step 1 – Identifying the place of use

- Place of use identified
- Recommended / suitable parasol models checked

Step 2 – Detailed situation analysis

- Spatial conditions – area & gradient measured?
(Take note of obstacles such as opening doors, roofs, railings, trees, ...)
 - What is to be shaded?
(Sizes and heights of furnishings)
 - Fixed anchorage possible?
(Surface characteristics & ground structure details)
 - Required wind stability? Special weather conditions & weather influences?
(Extreme location with wind, rain, snow or corrosion)
 - Have you checked the consulting guide for locations exposed to wind?
-
- Determine of parasol size including important measurements (headrooms, closing heights, ...)
 - Determine of fixation (fixed anchorage or base / parasol stands)
 - Choice of material (frame, fabrics / canopies, corrosion protection, ...)
 - Delivery / installation location accessible (lift, crane, ...)?

Step 3 – Specific customer requirements

Ambiance

- Is there harmony between the environment, architecture & furnishings?
- Choice of materials, fabric selection, RAL frame colour

Additional options

- Electronic equipment? (Motorisation, lighting, heating)
- Textiles? (Rain gutters, side walls)
- Material protection? (Protective covers, strap systems, impact protection)

Special product solutions

- Frame? (Special sizes, pole extension/reduction, frame colour)
- Canopy? (Special fabrics, flounces, printing / advertising print)
- Side walls?
- BUS system / connection to the home control system?

- Definition of parasol model including modifications
- Selection of additional options & special product solutions

Legal notice

Publisher	Glatz AG
Address	Glatz AG Neuhofstrasse 12 8500 Frauenfeld Switzerland
Contact	Telephone +41 52 723 66 44 contract@glatz.com
Photography	Glatz AG
Page 18, photo 01	Hannes Niederkofler
Page 18, photo 04	Falkensteiner Hotels & Residences
Page 22, photo 01	Anne Moscatello
Page 44, photo 02	Stefan Schütz
Page 48, photo 03	Quentin Alberola
Page 54, photo 03	TIROX Gastro GmbH
Page 58, photo 05	Monika Löff
Page 64, photo 01	Golfrestaurant Bürgenstock
Page 68, photo 01	Michael Haimburger
Page 68, photo 04	Bureau Rabensteiner

© All rights reserved.

Pictures must not be reproduced or used for other purposes without the written agreement of Glatz AG. Valid as of November 2022.

Marketing

Do you need some help with your communication activities? We would be happy to support you with suitable PR, photo and reference material.



Facebook



Instagram



YouTube



Restaurant Krelis, Uizgeest (NL) – PALAZZO® Royal

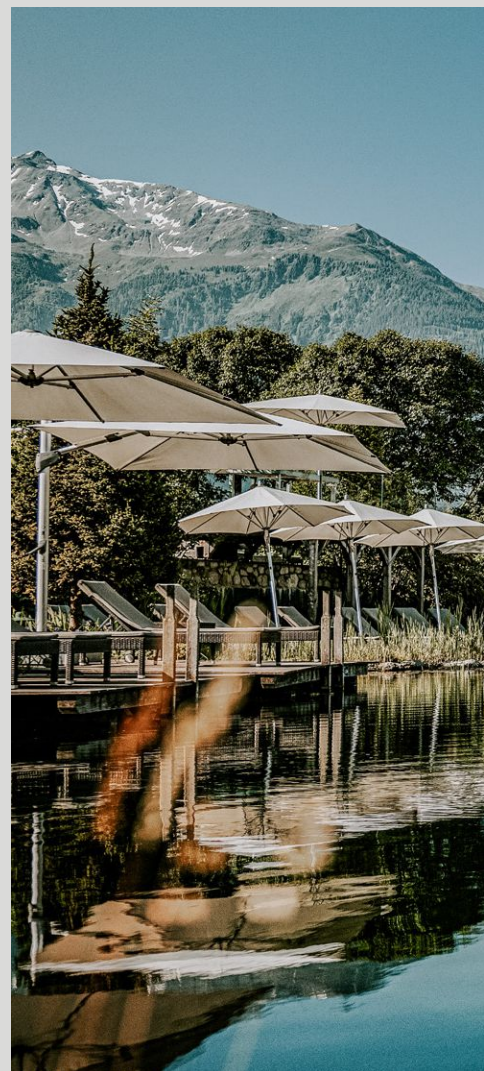

Glatz AG
Neuhofstrasse 12
8500 Frauenfeld
Switzerland

+41 52 723 66 44
contract@glatz.com
glatz.com

